

University of Nebraska - Lincoln

DigitalCommons@University of Nebraska - Lincoln

Architectural Engineering -- Dissertations and
Student Research

Architectural Engineering

12-2016

Appraisal of the Sustainability of Compressed Stabilized Earthen Masonry

Elena Claire Hoff

University of Nebraska-Lincoln, ehoff224@gmail.com

Follow this and additional works at: <http://digitalcommons.unl.edu/archengdiss>

Hoff, Elena Claire, "Appraisal of the Sustainability of Compressed Stabilized Earthen Masonry" (2016). *Architectural Engineering -- Dissertations and Student Research*. 43.

<http://digitalcommons.unl.edu/archengdiss/43>

This Article is brought to you for free and open access by the Architectural Engineering at DigitalCommons@University of Nebraska - Lincoln. It has been accepted for inclusion in Architectural Engineering -- Dissertations and Student Research by an authorized administrator of DigitalCommons@University of Nebraska - Lincoln.

Appraisal of the Sustainability of Compressed Stabilized Earthen Masonry

BY

ELENA CLAIRE HOFF

A THESIS

Presented to the Faculty of
The Graduate College at the University of Nebraska

In Partial Fulfillment of Requirements
For the Degree of Master of Science

Major: Architectural Engineering

Under the Supervision of Professor Ece Erdogmus

Lincoln, Nebraska

December, 2016

Appraisal of the Sustainability of Compressed Stabilized Earthen Masonry

Elena Hoff, M.S.

University of Nebraska, 2016

Advisor: Ece Erdogmus

Compressed stabilized earthen block (CSEB) masonry presents an environmentally and economically sustainable alternative to conventional residential construction materials such as clay brick masonry or concrete masonry (CMU). Earthen masonry is locally sourced and manufactured on site, thus minimizing costs associated with raw material extraction and transportation. Furthermore, CSEB requires very little use of electricity and water during both the manufacture and construction processes and it has excellent thermal resistivity while in use, allowing for additional cost and energy savings during most phases of its life cycle. Analyzing the life cycle trade-offs in a comparative study between CSEB and clay brick masonry supplements the existing recent research on earthen masonry and encourages a wider adoption of the technology around the world.

In this study, a comparative Life Cycle Analysis (LCA) is conducted between an exterior residential wall constructed of CSEB and one of clay brick for a proposed single family dwelling on the Winnebago Native American Reservation in Nebraska, USA. The scope of this LCA is narrowed to the impacts associated with choosing one construction material over the other, and the system boundary includes the raw material extraction, manufacturing, and transportation phases of construction.

Thermal conductivity is an important aspect of the energy efficiency of a building envelope during the use phase of a building's life cycle. As part of this study, an experimental program was conducted using a modified hotbox apparatus in order to obtain a thermal conductivity value for the CSEB blocks under investigation. After analysis, the thermal conductivity of the CSEB analyzed in this study is determined to be $0.361 \text{ W}/(\text{m}\cdot\text{K}) \pm 20.0\%$ compared to $1.024 \text{ W}/(\text{m}\cdot\text{K})$ for clay brick.

The three indicators for measuring the environmental or economic impacts of each material in this study are: 1) Energy, measured in kWh, 2) Global Warming Potential (GWP), measured in kg CO₂ eq., and 3) Cost, measured in US Dollars. The results of this Life Cycle analysis indicate that CSEB is the more economic and environmentally sustainable option, with the transportation phase of the life cycle of highest impact on cost.

Author's Acknowledgements

This research would not have been possible without the motivation and guidance, provided to me by my mentor, Dr. Ece Erdogan. Thank you for allowing me a path to pursue my passion for promoting a more sustainable future of the built environment through the use of environmentally optimal structural materials. Your drive for excellence is contagious and your encouragement of my ideas, as well as the acknowledgement of my successes, are greatly appreciated.

I would also like to take this opportunity to acknowledge the assistance of Luke Dolezal and Austin Seagren during the processing, manufacturing and lab testing stages of this research. Your support and drive for electrical knowledge was paramount in the success of this study and your camaraderie is appreciated beyond words.

To my peers who made themselves available to teach me how to use new lab equipment and help me process data, I am forever thankful. I wish you all the luck on your academic and professional endeavors. God speed.

Finally, thank you to my friends and family for your unwavering support throughout my academic journey. Your attention to my wellbeing while I'm most stressed is a mark of how fortunate I have been to have you in my life. You are an inspiration and I promise to be more present and relaxed in the future.

Table of Contents

AUTHOR'S ACKNOWLEDGEMENTS.....	IV
TABLE OF CONTENTS.....	V
LIST OF FIGURES.....	VIII
LIST OF TABLES	X
LIST OF EQUATIONS	XI
LIST OF SYMBOLS AND ABBREVIATIONS	XII
CHAPTER 1 : INTRODUCTION.....	1
1.1. BACKGROUND AND MOTIVATION	1
1.2. RESEARCH SIGNIFICANCE.....	3
1.3. GOALS AND OBJECTIVES.....	4
1.4. SCOPE.....	4
1.5. THESIS OVERVIEW.....	5
CHAPTER 2 : LITERATURE REVIEW.....	8
2.1. STRUCTURAL CHARACTERISTICS OF CSEB	8
2.2. SUSTAINABLE PERFORMANCE OF CSEB.....	9
2.3. THERMAL CONDUCTIVITY OF CSEB	10
2.4. THERMAL CONDUCTIVITY OF CLAY BRICK	13
2.5. DETERMINING THERMAL CONDUCTIVITY	14
CHAPTER 3 : EXPERIMENTAL THERMAL STUDY.....	17
3.1. RAW MATERIALS USED IN CSEB	17
3.2. MANUFACTURING CSEB.....	18
3.2.1. <i>Processing Soil</i>	18
3.2.2. <i>Manufacturing Blocks</i>	19
3.2.3. <i>Curing Process</i>	21
3.3. THERMAL CONDUCTIVITY TESTING METHODOLOGY	21

3.3.1. Test Set Up.....	21
3.3.2. Data Acquisition and Processing.....	25
3.4. THERMAL TEST RESULTS AND DISCUSSION	32
CHAPTER 4 : LIFE CYCLE ANALYSIS STUDY.....	34
4.1. LIFE CYCLE ANALYSIS METHODOLOGY	34
4.1.1. Scope and System Boundary	35
4.1.2. Construction Material Selection and Definition of Function Unit.....	39
4.1.3. Defined Indicators	41
4.2. COLLECTED LIFE CYCLE INVENTORY (LCI)	42
4.2.1. Indicator 1: Energy	42
4.2.2. Indicator 2: GWP	44
4.2.3. Indicator 3: Cost	44
4.3. LCI DATA CONVERSION	46
4.4. TRANSPORTATION PHASE CALCULATIONS.....	47
CHAPTER 5 : LIFE CYCLE ANALYSIS RESULTS AND DISCUSSION	50
5.1. INDICATOR 1: ENERGY USE.....	50
5.2. INDICATOR 2: GWP	52
5.3. INDICATOR 3: COST.....	54
CHAPTER 6 : UNCERTAINTY AND SENSITIVITY ANALYSIS.....	57
6.1. UNCERTAINTY WITHIN THE DATA COLLECTED	57
6.2. UNCERTAINTY AND SENSITIVITY ANALYSIS WITHIN THE METHODOLOGY.....	59
CHAPTER 7 : APPLIED THERMAL CONDUCTIVITY IMPACTS.....	65
7.1. INDICATOR 1: ENERGY USE.....	67
7.2. INDICATOR 2: GWP	68
7.3. INDICATOR 3: COST	69
CHAPTER 8 : CONCLUSIONS.....	70
REFERENCES	73

GLOSSARY OF TERMS.....	78
LCA AND THERMAL CALCULATIONS.....	79
GEOTECHNICAL DATA	82

APPENDIX A :

APPENDIX B :

APPENDIX C :

List of Figures

FIGURE 2-1: TRANSIENT HOT WIRE METHOD USED IN BALAJI ET. AL. 2016	15
FIGURE 3-1: POWER MIXING OF SOIL-CEMENT MIXTURE	19
FIGURE 3-2: TAMPING THE SOIL-CEMENT MIXTURE INTO THE BLOCK PRESS	20
FIGURE 3-3: FINISHED CSEB AFTER BLOCK PRESS	20
FIGURE 3-4: MODIFIED HOT BOX DIAGRAM	22
FIGURE 3-5: MODIFIED HOT BOX SET UP	22
FIGURE 3-6: THERMOCOUPLES ON EXTERIOR OF CSEB	23
FIGURE 3-7: THERMOCOUPLES ON INTERIOR OF CSEB	23
FIGURE 3-8: FLEXIBLE STRIP HEATER ON EXTERIOR SIDE OF CSEB	24
FIGURE 3-9: SCHEMATIC CIRCUIT DIAGRAM	25
FIGURE 3-10: TEMPERATURE (°C) VS. TIME (MIN.)	27
FIGURE 3-11: INFRARED IMAGE OF UNCOVERED CSEB DURING HEATING	28
FIGURE 3-12: INFRARED IMAGE OF CSEB FROM INSIDE PROTECTIVE CHAMBER DURING HEATING	28
FIGURE 3-13: THERMAL CONDUCTIVITY OF A TYPICAL CSEB	31
FIGURE 4-1: SINGLE FAMILY DWELLING IN 3D (LEFT) AND PLAN VIEW (RIGHT) (ERDOGMUS ET AL. 2015A)	36
FIGURE 4-2: SYSTEM BOUNDARY OF LCA STUDY	37
FIGURE 4-3: CSEB FABRICATED AT UNIVERSITY OF NEBRASKA- LINCOLN	40
FIGURE 4-4: TYPICAL CLAY BRICK USED IN THIS STUDY	41
FIGURE 5-1: RESULTS OF LCA - ENERGY CONSUMPTION COMPARISON	51
FIGURE 5-2: RESULTS OF LCA - GLOBAL WARMING POTENTIAL (GWP) COMPARISON	53
FIGURE 5-3: RESULTS OF LCA – COST COMPARISON	54
FIGURE 6-1: SENSITIVITY TO VARYING LABOR EFFICIENCY IN CSEB RAW MATERIAL EXTRACTION	59
FIGURE 6-2: SENSITIVITY TO USE OF POWER DRILL IN CSEB MIXING	61
FIGURE 6-3: SENSITIVITY TO INCREASED TRAVEL DISTANCE OF CLAY BRICK	62
FIGURE 7-1: THERMAL CONDUCTIVITY: ENERGY CONSUMPTION (kWh) PER 5FT WALL SEGMENT	68

FIGURE 7-2: THERMAL CONDUCTIVITY: GLOBAL WARMING POTENTIAL (KG CO ₂ EQ.) PER 5FT WALL SEGMENT.....	68
FIGURE 7-3: THERMAL CONDUCTIVITY: COST (\$) PER 5FT WALL SEGMENT	69
FIGURE A-1: BATCH 9 - AGGREGATE GRADATION CHART.....	84
FIGURE A-2: BATCH 9 - AGGREGATE GRADATION CHART.....	86

List of Tables

TABLE 2-1: THERMAL CONDUCTIVITY OF CSEB FOUND IN LITERATURE	13
TABLE 3-1: SOIL PROPERTIES.....	18
TABLE 3-2: THERMAL CONDUCTIVITY RESULTS.....	32
TABLE 4-1: SUMMARY OF LIFE CYCLE PHASES USED IN THE LCA	38
TABLE 4-2: CONVERSION FACTORS	42
TABLE 4-3: SUMMARY OF LIFE CYCLE INVENTORY DATA.....	46
TABLE 4-4: BLOCK EQUIVALENCY.....	47
TABLE 4-5: TRANSPORTATION PHASE DATA	49
TABLE 5-1: ENERGY CONSUMPTION (KWH) PER 5FT WALL SEGMENT	50
TABLE 5-2: GLOBAL WARMING POTENTIAL (KG CO2 EQ.) PER 5FT WALL SEGMENT	52
TABLE 5-3: COST (\$) PER 5FT WALL SEGMENT	54
TABLE 7-1: HEAT TRANSFER RATE OF CSEB AND CLAY BRICK.....	67
TABLE 7-2: ENERGY COSTS PER TYPICAL SEASONAL DAY FOR EACH BLOCK.....	67
TABLE A-1: RAW MATERIAL EXTRACTION AND MANUFACTURING LCA CALCULATIONS.....	79
TABLE A-2: TRANSPORTATION LCA CALCULATIONS.....	79
TABLE A-3: APPLIED THERMAL CALCULATIONS.....	80
TABLE A-4: GWP PER TYPICAL SEASONAL DAY FOR EACH BLOCK	80
TABLE A-5: COST PER TYPICAL SEASONAL DAY FOR EACH BLOCK	81
TABLE A-6: BATCH 8 - DRY SIEVE TEST	82
TABLE A-7: BATCH 8 - ATTERBURG LIMITS.....	82
TABLE A-8: BATCH 9 - DRY SIEVE TEST	83
TABLE A-9: BATCH 9 - ATTERBURG LIMITS.....	83
TABLE A-10: BATCH 10 - DRY SIEVE TEST	85
TABLE A-11: BATCH 10 - ATTERBURG LIMITS.....	85

List of Equations

(Eq. 2.1)	14
(Eq. 3.1)	29
(Eq. 3.2)	29
(Eq. 3.3)	30
(Eq. 3.4)	30
(Eq. 6.1)	57
(Eq. 6.2)	57
(Eq. 7.1)	65
(Eq. 7.2)	66

List of Symbols and Abbreviations

%	Percent
°F	degree Fahrenheit
°C	degree Celsius
\$	dollar (U.S.)
"	inch
3D	three dimensions
BTU	British thermal unit
CSEB	Compressed Stabilized Earthen Block
CO ₂	Carbon Dioxide
cm	centimeter
eq.	equivalent
EPA	U.S. Environmental Protection Agency
ft	feet
GHG	greenhouse gas
GJ	gigajoule
GWP	global warming potential
hr	hour
in	inch
k	thermal conductivity in W/(m·K)
K	degree kelvin
kg	kilogram
kJ	kilojoule
km	kilometer
kwh	kilowatt hour
lb	pound
LCA	life cycle analysis
LCI	life cycle inventory
m	meter
min	mins
MJ	megajoule
ml	milliliter
mm	millimeter
mpg	miles per gallon
psi	pound per square inch
ρ	dry density in g/cc
T	temperature in °C, °F, or K
W	Watt

Chapter 1 : Introduction

1.1. Background and Motivation

According to the United Nations Environment Programme, the building sector is responsible for up to 40% of global energy and resource consumption, as well as 30% of all energy-related Green House Gas (GHG) emissions, most notably in the form of CO₂.

Due to the magnitude of its impact on the environment, this sector has the unique opportunity to confront the current disregard of Earth's bio-capacity and make a significant dent in climate change (Graham and Booth 2012). Due to the growing interest in environmental awareness and sustainable design of the built environment throughout the past few decades, engineered earthen construction options have received increased attention in many academic realms.

Earth construction has been a prominent building technique throughout history and remains crucial to the construction of residential dwellings across many developing regions. It has been estimated that, as of 2016, up to 30% of the global population continues to reside in housing made of earth (Costa et al. 2016). This abundant building system touts many sustainable advantages including minimal carbon emissions, reduced energy consumption, renewable materials that are often extracted from the construction site itself, and local, unskilled labor (Reddy and Kumar 2010). Compared to modern alternatives, earth construction alleviates pressure on natural raw material resources that are often produced and consumed in bulk quantities and eliminates the

need for energy intensive manufacturing processes and transportation over long distances (Reddy 2009).

Earthen construction presents itself frequently in the form of rammed earth walls and earthen masonry. Rammed earth walls are manufactured in place by constructing formwork and compacting layers of each wall until it reaches the desired height.

Earthen masonry, on the other hand, is manufactured in discrete units and assembled in place with mortar, much like typical clay brick or concrete masonry construction. As the available soil may have limited structural properties, each type of earth construction has the possibility to be stabilized or reinforced to aid in strength and durability.

Compared to other forms of earth construction, earthen masonry has the advantages of prefabrication. Since the discrete block units have the flexibility of being produced offsite, the production process can occur independent of weather, shrinkage issues are not a concern, the units can be tested for strength before use, and there is a greater consistency in fabrication allowing for more accurately engineered designs (Williams et al. 2010).

On-going research by a team at the University of Nebraska – Lincoln is analyzing the structural performance of Compressed Stabilized Earthen Masonry (Colley and Erdogmus 2015; Erdogmus and Garcia 2015; Erdogmus et al. 2013). Previous studies have determined that an optimal stabilizer content of 10% cement by weight is necessary to ensure durability and adequate compressive strength of the earth blocks.

Further investigation into the sustainability of this building system is highly desired in order to provide a complete argument for increased adoption of the building system.

1.2. Research Significance

As previously stated, engineered earth construction is in the unique position to prove its touted environmental benefits of low embodied energy, minimal impact from use of abundant natural resources, and excellent thermal performance. It is a general consensus in the community of modern earth construction investigators that this building material is the more economic and environmentally sustainable option compared to its conventional counter parts (such as clay brick, concrete masonry, or reinforced concrete.) Unfortunately, little work has been published to confirm this hypothesis even though some studies exist on the embodied energy, associated global warming potential, and thermal performance of earthen construction.

Currently, there are a lack of existing life cycle studies to make the case for the implementation of engineered earthen masonry as a feasible alternative to conventional building materials such as clay brick. Due to compelling competition from alternative building materials, the holistic impacts associated with material composition and thermal insulating properties of CSEB must be investigated (Balaji et al. 2016; Dondi et al. 2004). In order to resolve this need, this study conducts a comparative life cycle analysis between CSEB and clay brick masonry with use of primary experimental data for the thermal conductivity of the CSEB composition in analysis.

1.3. Goals and Objectives

The goal of this study is to analyze the environmental and economic impacts of these different construction alternatives in a specific case that can be explored as a way to provide fair comparison. The aim of this study is to assess the potential for minimizing specific environmental impacts (CO₂ emissions and energy use) and economic impact (cost) associated with the use of CSEB. The objectives to reach this goal are as follows:

- 1) Determine the thermal conductivity of the considered Compressed Stabilized Earthen Blocks (CSEB).
- 2) Conduct a Life Cycle Analysis in order to compare the CSEB and clay brick and quantify the sustainability of these alternatives.
- 3) Investigate the potential impact of choosing CSEB instead of clay brick in a building envelope in terms of differing thermal conductivity.

1.4. Scope

The scope of this study is contained to determining the thermal conductivity of a precise mixture of CSEB and to analyze the environmental and economic impacts of that CSEB compared to clay brick. This study does not include investigation into accessories to either building system, such as associated mortar, insulation and other building enclosure elements. The system boundary of the cradle-to-site LCA includes the raw material extraction, manufacturing, and transportation phases of the life cycle of the CSEBs and clay bricks. The thermal conductivity of the earth block measured during the

experimental stage of this study is used to calculate energy savings, reduced global warming potential and cost savings between CSEB and Clay Brick for a few snapshot days during the use of the residential dwelling.

1.5. Thesis Overview

This thesis contains seven chapters. A description of the following chapters is listed below.

- Chapter 2: Literature Review. This chapter contains a literature review including the structural performance of CSEB and sustainable investigations into earth construction. Thermal conductivity is defined and factors that have been determined to affect thermal performance in stabilized earth blocks are discussed. A few bench marks on thermal conductivity values of both CSEB and clay brick are offered for comparison.
- Chapter 3: Experimental Thermal Study. An experimental study was completed on the CSEB in order to determine their thermal conductivity. The research method for thermal testing on the blocks is outlined and discussed in this section. All ASTM standard tests used in this study and any modifications to them are explained in this chapter. Results for the thermal study are presented and discussed, offering a final value for thermal conductivity.
- Chapter 4: Life Cycle Analysis. A comparative Life Cycle Analysis is conducted in order to investigate the economic and environmental impacts associated

with the choice between using CSEB or clay brick as a primary building component. The CSEB under investigation is the same mix design as in the thermal study in Chapter 3 and the clay brick originates from a manufacturer in Lincoln, NE. The analysis includes cradle-to-site life cycle phases and looks at the impacts of a 5ft segment of a 12ft tall exterior wall of a residential dwelling on the Winnebago Native American Reservation in north eastern Nebraska. The impacts under investigation include 1) Energy, measured in kWh, 2) Global Warming Potential (GWP), measured in kg CO₂ eq., and 3) Cost, measured in US Dollars.

- Chapter 5: Results and Discussion. In this chapter the results from the Life Cycle Analysis are combined and illustrated with a brief explanation as to the largest contributing factors. These results are compared to those found in the literature and reasoning for the outcomes is also offered.
- Chapter 6: Uncertainty and Sensitivity Analysis. Uncertainty in the methodology that results in the findings is discussed in this chapter. In order to fully understand the effects of the assumptions made during the LCA, a sensitivity analysis is performed on a few key assumptions.
- Chapter 7: Applied Thermal Conductivity Impacts. This chapter ties together the experimental thermal study and the LCA conducted in the previous chapters by analyzing the impacts associated with the thermal conductivity of each building material. Since a complete Life Cycle Analysis of the energy efficiency of the entire building system is not within the scope of this study,

simplified snapshots representing a typical day in each of the four seasons are analyzed in order to further compare the economic and environmental impacts. This small glimpse into the greater picture is very informative, however, it would not be prudent to include this portion of the study with the larger Life Cycle Analysis due to over simplification of the use phase throughout the entire lifetime of the building.

- Chapter 8: Conclusions. In this chapter, conclusions are made providing advice for desirable options within the CSEB building system. This chapter also elaborates on future studies that will be beneficial to the subject matter.
- Appendix A: A glossary of terms used throughout this study is provided.
- Appendix B: This appendix contains raw data used to obtain the experimental thermal test results.
- Appendix C: Additional documentation involved in the geotechnical testing are provided in this section.

Chapter 2 : Literature Review

Compressed stabilized earthen block masonry (CSEB) is an earthen masonry, engineered to maximize strength and durability with minimum use of a stabilizing agent. CSEBs are unique compared to conventional building materials in that they can be molded to the desired size, shape or density by the end user. These blocks can also be designed for the required strength by either varying the amount and type of stabilizer content – such as lime or cement – or adding structural reinforcement in order to meet building standards (Meukam et al. 2004).

2.1. Structural characteristics of CSEB

Both the mechanical and structural characteristics of CSEB have been researched extensively - including manufacturing technique, block density, level of compaction, type and amount of stabilizer used, soil-stabilizer ratio, addition of fibers or other additives, curing conditions, temperature in the early days after casting, etc. (Meukam et al. 2004). Specific considerations affecting structural performance have also been prominently recognized in terms of varying clay content, cement content and densities for durability and strength (Balaji et al. 2016). Previous studies have shown that stabilizing the earthen masonry with a low percentage (6-10%) of cement and compressing the units in a manual or hydraulic molding device to a density of about 0.06 lb/in³ can yield strong, water-resistant wall sections (Erdogmus and Garcia 2015; Colley 2014; Colley and Erdogmus 2015). Minimizing the quantity of cement used in CSEB is

environmentally optimal. However, research suggests that cement content of at least 10% is necessary to limit water absorption (Meukam et al. 2004), essential to stabilize CSEB made from soils with dispersive clays (Colley and Erdogmus 2015) and results in a compressive strength of 5.9 MPa (Erdogmus and Garcia 2015).

There are also other comprehensive studies on the structural composition of CSEB masonry including investigation of factors that affect compressive strength of the blocks, mortar, and block-mortar assemblies (Riza et al. 2010; Reddy and Gupta 2005) and optimized earth-mortar mixtures (Ouda 2009). The effects of polyethylene terephthalate fibers in the stability of blocks (Colley 2014) and consistency of fiber-reinforced mortars (Erdogmus et al. 2013) were also investigated in recent years.

2.2. Sustainable performance of CSEB

Additional exploration into the sustainable factors of engineered earthen construction includes total embodied energy in rammed earth walls (Reddy and Kumar 2010), the low carbon emissions of sustainable materials (Reddy 2009) and the economic feasibility of earth block masonry for sustainable walling (Williams et al. 2010). These studies have found that CSEBs can have a total embodied energy of 0.5-0.6 GJ/m³ and that the production of earthen blocks can consume as little as 14% of the energy used to produce clay bricks (Williams et al. 2010). Further, Reddy and Kumar (2010) reported that embodied energy used to produce earthen walls of 8-12% cement can range from 0.50-0.75 GJ/m³.

2.3. Thermal Conductivity of CSEB

A notable sustainable factor under recent investigation for engineered earth blocks is their thermal conductivity – an intrinsic property of the material that determines the quantity of heat conducted through it for a given temperature gradient. Thermal conductivity is defined as “the mechanism of heat transfer between parts of a continuum due to the transfer of energy between particles or groups of particles at the atomic level,” (McQuiston et al. 2005). Minimizing thermal conductivity in the building envelope is the goal of most product design as to reduce heat transfer through these components in order to provide insulation to the indoor space or to decrease the energy consumption of building facilities such as air-conditioners or heaters (Khedari et al. 2005). As heat can be conducted or radiated through a series of materials combined in the form of a building envelope, these internal heat transfer process are reported in terms of a single thermal conductivity value, k , and measured in $W/(m \cdot K)$ (Balaji et al. 2016).

Density parameters, including void ratio, porosity and degree of compaction, have been found to have a significant impact on the thermal conductivity of CSEB. Initial reports of the effect of stabilizers on the density and pore size of the blocks presented that the pore size of the block decreases with an increase in cement content (Reddy and Gupta 2005) and found a relationship for thermal conductivity between stabilization and dry density (Adam and Jones 1995). Reddy and Latha (2014) further investigated the influence of clay content on the void ratio of cylindrical soil–cement specimens with 7%

cement showing that the percentage of sand, silt and clay size fractions decreases as the cement content increases.

In a 2004 study, Dondi et al. (2004) found a correlation between the thermal conductivity of clay bricks and their mineralogical composition and microstructure in their study on the thermal conductivity of clay bricks. This study suggests that the thermal conductivity of engineered earthen masonry has a strong correlation with the cement content and dry density of the blocks. Balaji et al. (2015) thoroughly examined the influence of the clay content, cement content and dry density of each block on the thermal conductivity of their soil-cement blocks. This study supports that the thermal conductivity of the blocks increases with an increase in cement content, clay content, and dry density. Further, Balaji et al. (2016) notes the established principle that thermal conductivity is a function of density, which is a function of porosity and that density and the measure of air-filled pores, or voids, in the material are inversely proportional. Air within the pores has a thermal conductivity value of $0.025 \text{ W}/(\text{m}\cdot\text{K})$ and high thermal resistivity resulting in a heat transfer medium that regulates the heat flow through the earth block. Therefore, a reduction in thermal conductivity can be obtained by lowering the density of a material, thus increasing the porosity.^A For instance, at room

^A However, this practice would, in turn, decrease the strength of the blocks.

temperature, a 100 kg/m^3 density increase results in a 12.5% increase of thermal conductivity of CSEB.

Beyond dry density and porosity, it is quite evident that numerous factors affect the thermal conductivity of engineered earthen masonry. Adam and Jones (1995) noted the samples stabilized by lime were found to have a lower thermal conductivity than those of stabilized by cement. Another study from 1995 suggests that thermal conductivity of earthen blocks decreases over time as the blocks continue to cure (Nagih and Ali 1995). Balaji et al. (2015) also points out in their study on cement-stabilized soil blocks that thermal conductivity of a building component relies on the material of which it is comprised, but also on its temperature, as it is often exposed to extreme external temperature conditions. Further, a study by Meukam et al. (2004) found that the thermal conductivity of CSEB increases with water content due to the fact that the thermal conductivity coefficient of water ($0.6 \text{ W/m}\cdot\text{K}$) is higher than that of the air in the voids that it replaces.

Specific research on the thermal conductivity of engineered earth blocks report a wide range of values highly dependent on the stabilizer content, porosity and age of curing. In a 1989 study, Bhattacharjee found a range of thermal conductivity values from 0.501 to $0.768 \text{ W}/(\text{m}\cdot\text{K})$ for cement content ranging between 4 to 10% and a porosity range from 36 to 43% (Bhattacharjee 1989). The study by Adam and Jones (1995) that investigated thermal conductivity of non-compressed stabilized earthen material found values in the range of $0.25\text{--}0.55 \text{ W}/(\text{m}\cdot\text{K})$ by comparing cement to lime as a stabilizing agent in oven-

dried samples with 0.1-0.5% moisture by volume. In their study on the influence of various mix proportions, Balaji et al. (2015) reported that thermal conductivity was between 0.84 W/(m·K) to and 1.30 W/(m·K) with clay content ranging from 16 to 31.6%, cement content anywhere from 5 to 16%, and dry density from 1700 to 1900 kg/m³. A study by (Khedari et al. 2005) reported a thermal conductivity value of 0.65 W/(m·K) for a soil-cement block with a bulk density of 1587 kg/m³. This study reports slightly lower densities than those in other studies due to the use of natural additives shown to reduce thermal conductivity, however due to their low compressive strength of 2.45 MPa, these blocks are not considered adequate for load-bearing structural use. The significant thermal conductivity values found in the literature are listed in Table 2-1.

Table 2-1: Thermal Conductivity of CSEB found in Literature

Source	Thermal Conductivity (W/mK)	Clay Content	Cement Content	Moisture Content	Density (kg/m ³)
Balaji et al. 2015	0.84 - 1.30	16-32%	5-16%	--	1700-1900
Bhattacharjee 1989	0.50 - 0.77	--	4-10%	--	
Adam and Jones 1995	0.25 - 0.55	--	--	0.1-0.5%	--
Khedari, et al. 2005	0.65	--	--	--	1587

2.4. Thermal Conductivity of Clay Brick

A variety of values for thermal conductivity of clay bricks have been published through extensive research. Factors affecting the thermal performance of clay brick can be

attributed to porosity, bulk density, as well as size and shape of pores, much like the CSEB (Dondi et al. 2004). For purposes of comparison, (Balaji et al. 2016) cites a source stating that “burned brick” has a thermal conductivity of 1.31 W/(m·K). (McQuiston et al. 2005) reports a thermal conductance of 6.4-7.8 BTU-in/(ft²·h·°F) for clay brick that has a density of 130 lb/ft³ and 5.6-6.8 BTU-in/(ft²·h·°F) for brick that has a density of 120 lb/ft³. These values converted to SI units are 0.90-1.09 W/(m·K) and 0.78-0.95 W/(m·K) for blocks of densities 2080 and 1920 kg/m³, respectively.

(Dondi et al. 2004) reported a collection of thermal conductivity values for clay bricks from literature and combined that input with their own experimental study. As a discussion point for results, Dondi et al. fit a linear approximation curve between bulk density and thermal conductivity, but carefully noted that bulk density is not the only contributing variable. This formula can be seen in Equation 2.1, below.

$$k = .175 + 3.833 \times 10^{-4}d \quad (\text{Eq. 2.1})$$

Where,

k = thermal conductivity, W/(m·K)

d = density, kg/m³

2.5. Determining thermal conductivity

A few different methods of determining thermal properties of CSEB can be found throughout the literature. Each method falls under one of two types of heat transfer: or transient. A transient method often involves an increase in heat applied, easily

measured in a temperature increase on the hot side of the specimen over a given period of time. A is achieved when there is no increase in heat applied and the temperature of the block remains constant.

(Balaji et al. 2016) used a QTM-500 instrument (Figure 2-1) following the (ASTM C1113 1999) standard based on the transient hot wire method and aluminum foil was used to reduce heat loss between the specimen and ambient air. The thermal conductivity of clay bricks was determined in the study by (Dondi et al. 2004) by means of a Dynatech TCFGM apparatus using the hot plate method according to the UNI 7745 (1977) standard. The cylindrical soil-cement specimens in the study by (Nagih and Ali 1995) were oven dried and cooled to room temperature prior to testing with thermocouples embedded on either end. Unfortunately, the exact method of determining thermal conductivity in this study is unclear.

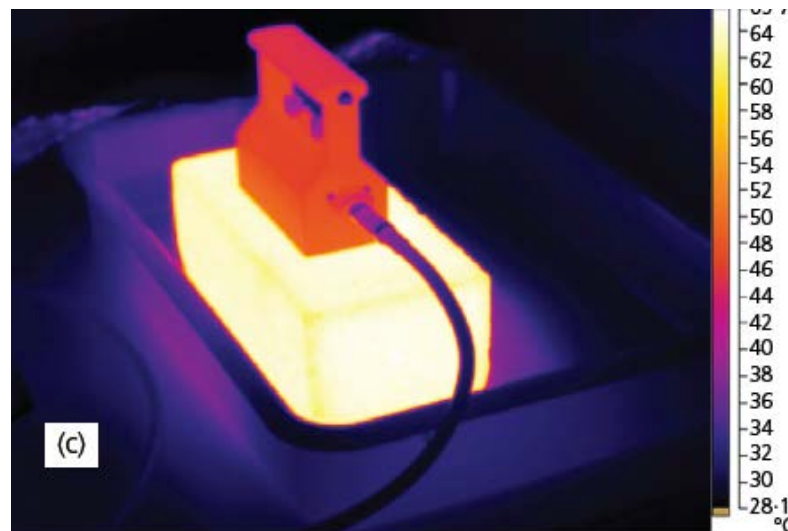

Figure 2-1: Transient Hot Wire Method used in Balaji et. al. 2016

Finally, use of a hot box apparatus is another accepted method of determining thermal performance of a homogeneous building material under conditions (ASTM C1363 2011). Further study into the most effective method for investigation thermal performance of a compressed earthen block is required in order to determine the optimal technique.

Chapter 3 : Experimental Thermal Study

As noted in the literature, the thermal conductivity of CSEB is highly dependent on the clay content of the soil and the density and cement content of the stabilized earth block. In order to fully understand the thermal performance and environmental and economic implications of this particular CSEB under investigation in this study, an experimental program is conducted.

3.1. Raw Materials used in CSEB

CSEBs are composed of soil most often local to the construction site. For this study, soil was gathered from one site located in Winnebago, NE and two different locations in Omaha, NE, and then characterized and proportionally combined for block manufacturing. Previous studies have characterized the clay found in the Winnebago soil as dispersive clay (Colley 2014). Dispersive clays are often undesirable for structural applications, however research has shown that CSEB made of this particular soil can have adequate compressive strength with 10% cement stabilization (Erdogmus and Garcia 2015).

Table 3-1 summarizes the clay content, plasticity index and Unified Soil Classification System for each batch used. Batch A was collected from the Winnebago Native American Reservation, Batch B was collected from the beginning of a large excavation on the University of Nebraska – Lincoln, Scott Campus, and Batch C was collected from the end of the excavation on the Scott Campus. The tests used to characterize these

soils were the Atterberg limit test and the dry sieve test as established by the American Society of Testing Methods (ASTM) guidelines (ASTM D422-63 2007; ASTM D4318-10e1 2014). Soils from Batch A and Batch B are both classified as well-graded sand with clay, whereas soil from Batch C is classified as poorly graded sand. Additionally, ordinary Type I/II Portland cement was used as a binder/stabilizer material for the CSEBs in this study.

Table 3-1: Soil Properties

Batch	Location	Clay Content	Plasticity Index (PI)	USCS Classification
Batch A	Winnebago, NE	5.3%	6.21	SW-SC
Batch B	Omaha, NE	5.4%	5.95	SW-SC
Batch C	Omaha, NE	--	--	SP

3.2. Manufacturing CSEB

A brief description of the manufacturing processes is presented in this section as they pertain to the specific mix design used in this study.

3.2.1. Processing Soil

The unprocessed soil was air dried until considered workable and then mechanically sieved by using a Gilson Model TS-1 testing screen. The soil passed through screens in the following order: 0.50in (12.7mm), 0.25in (6.35mm), and then #6 (0.132in or 3.36mm) until its particle sizes were adequate for block manufacture. Relatively small

soil particles are desirable as they allow the dry cement to mix homogeneously. After processing the soil, moisture content tests were conducted in accordance with (ASTM D2216-10 2010) to ensure that the soil-cement mixture would cure consistently. The moisture content of the soil for the fabrication of these blocks was 16.5% by weight. The three batches of soil (Batch A, Batch B and Batch C) were subsequently combined and thoroughly mixed in a 1.5 : 1 : 1.5 ratio by weight, respectively, in order to remain consistent with ongoing parametric studies.

3.2.2. Manufacturing Blocks

The manufacturing process began by mixing the combined soil with the cement. The cement content chosen for analysis was 10% by weight, and thus the soil and cement were mixed together in a 9:1 ratio by weight. For ease of mixing, a power drill and 5-gallon buckets were used and the contents of each block were split in two, as depicted in Figure 3-1.



Figure 3-1: Power mixing of soil-cement mixture

After each bucket was thoroughly combined, the mixture was placed in the mold and manual pressure was applied to the block press. The CSEB were cast by the block making device manufactured by 'Open Source Resilient Living' and the procedure followed ASTM D1632-07 (2007) regarding the use of a release agent and tamping to ensure compaction, as depicted in Figure 3-2 and Figure 3-3.



Figure 3-2: Tamping the soil-cement mixture into the block press



Figure 3-3: Finished CSEB after block press

3.2.3. Curing Process

Once the blocks were cast, each specimen was carefully removed from the mold, weighed, measured and placed into an air-tight plastic bag to be cured for 28 days. At the end of the 28-day curing period, dry measurements were taken for the individual block's weight and volumetric dimensions to determine shrinkage and weight loss. For this batch, 99.6% of the weight was retained during the curing process and the average dry density of the specimens was 0.658 lb/in³ (1821 kg/m³).

3.3. Thermal Conductivity Testing Methodology

Due to the nature of compressed earthen masonry, the compaction during the manufacturing process eliminates the possibility to form the blocks with temperature probes inside. Instead, a modified hot box apparatus was constructed utilizing the steady-state technique in order to measure the thermal conductivity of the block.

3.3.1. Test Set Up

In order to maintain a consistent testing environment, a 3'-0" X 2'-6" X 2'-6" modified hot box structure (Figure 3-4 and Figure 3-5) was constructed from 1 ½" blue foam insulation conforming to ASTM C518 (2015) with an R value of 5.0/in (7.5 ft²·h·°F/BTU). This particular insulation was chosen based on availability and ease of construction. Liquid Nails adhesive and spray insulation were used to properly construct and seal the container on all sides except for the top to give easy access to the inside of the box. A portal was cut through one side of the container to the exact dimensions of a CSEB.

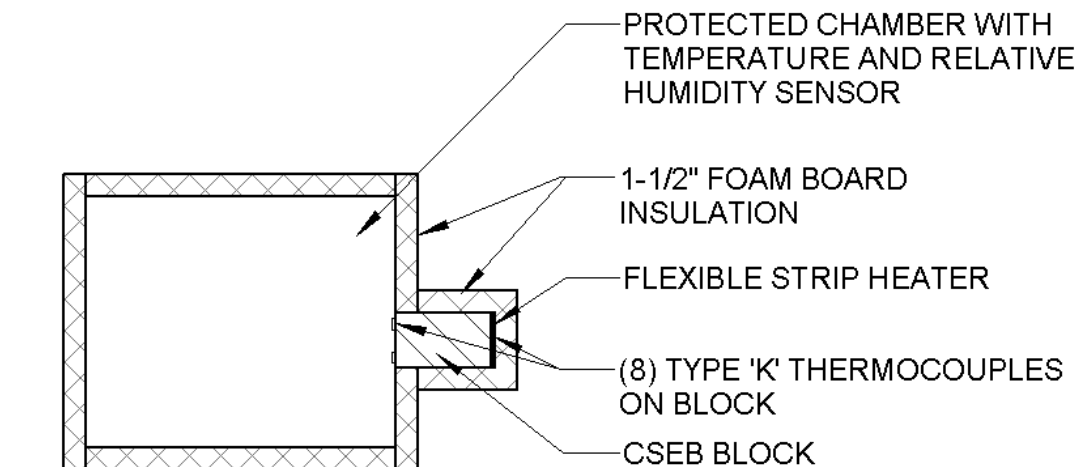

SECTION VIEW

Figure 3-4: Modified hot box diagram



Figure 3-5: Modified hot box set up

During testing a block would sit on an exterior shelf covered completely by insulation with its interior face exposed to the inside chamber. As pictured in Figure 3-6 and Figure 3-7, a total of eight Type K thermocouples ($\pm 2.2^{\circ}\text{C}$) (Omega 2016) were used to measure temperature differences across the block throughout the testing period, four on the inside and four on the outside. A hygrometer probe was also placed inside the chamber to manually monitor the temperature and relative humidity during testing in order to ensure that the temperature of the chamber was not significantly increasing.

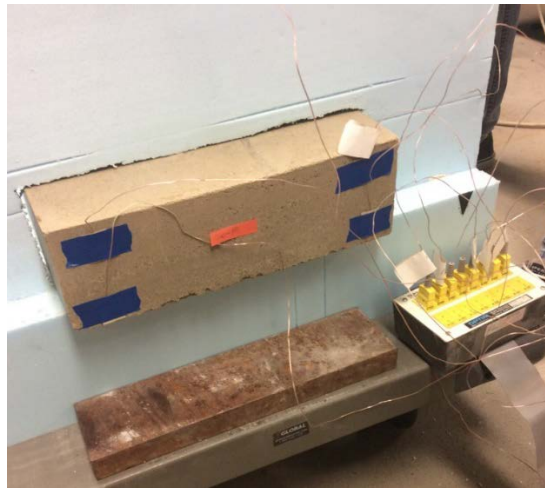

Figure 3-6: Thermocouples on exterior of CSEB

Figure 3-7: Thermocouples on interior of CSEB

A TEMPCO Flexible Strip Heater rated for 360W with dimensions 12" X 3" was mounted on the external face of each block and on top of the external thermocouples, as illustrated in Figure 3-8. Care was taken to fit insulation around all external sides of the block to ensure minimal heat escape. The test set up can be characterized as a modified hot box since the heat is applied to the external surface of the block and transferred through the block toward the protective chamber, opposite of the direction of a traditional hotbox. Meukam et al. (2004) notes that, given the geometry of the specimen and that the test is designed with precaution in order to limit the lateral heat lost, it is safe to regard the process as unidirectional heat transfer since the materials have been assumed to be homogeneous and isotropic.



Figure 3-8: Flexible strip heater on exterior side of CSEB

In order to reduce the voltage applied to the heater and slow down the heating process to ensure the melting point of the insulation was not reached, two 50 ohm resistors were added to the circuit in series. This addition reduced the power to the heater by

approximately 55%. A schematic diagram of the circuit is provided in Figure 3-9 including a 120 volt power supply, two power resistors and a heater.

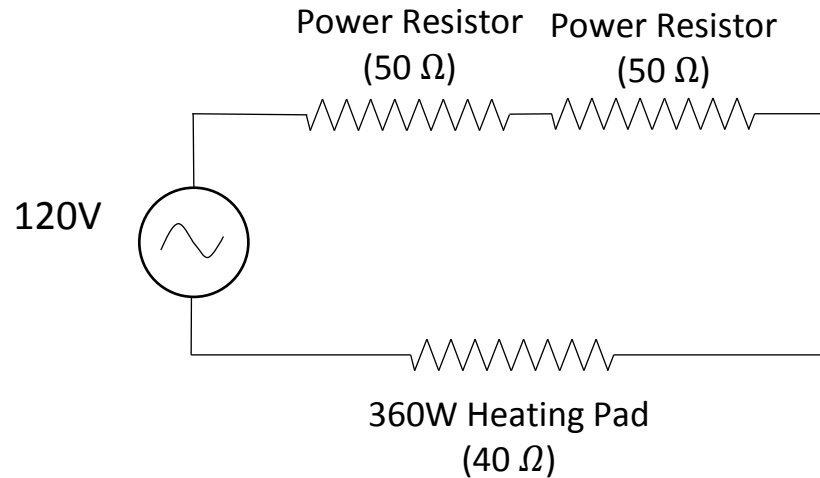

Figure 3-9: Schematic circuit diagram

3.3.2. Data Acquisition and Processing

The voltage from the thermocouples were monitored and recorded at a frequency of 1hz by the Optim MegaDAC and the TCS software converted the potential difference to a calibrated temperature in °C. Calibration occurred inside the data acquisition system and was conducted at the beginning of each sample.

Figure 3-10 illustrates the average temperature differential between the interior and exterior thermocouples over a time period of three and a half hours with constant heat applied. It is evident that after about three hours of testing, the CSEB reaches a pseudo-steady-state in that over a 30-minute period the temperature differential between the interior and exterior of the block only increases by 0.63 °C or 0.9%. This difference is less

than the 1% threshold established by the ASTM guidelines on calculating thermal transmission properties under steady-state conditions (ASTM C1045-07 2013).

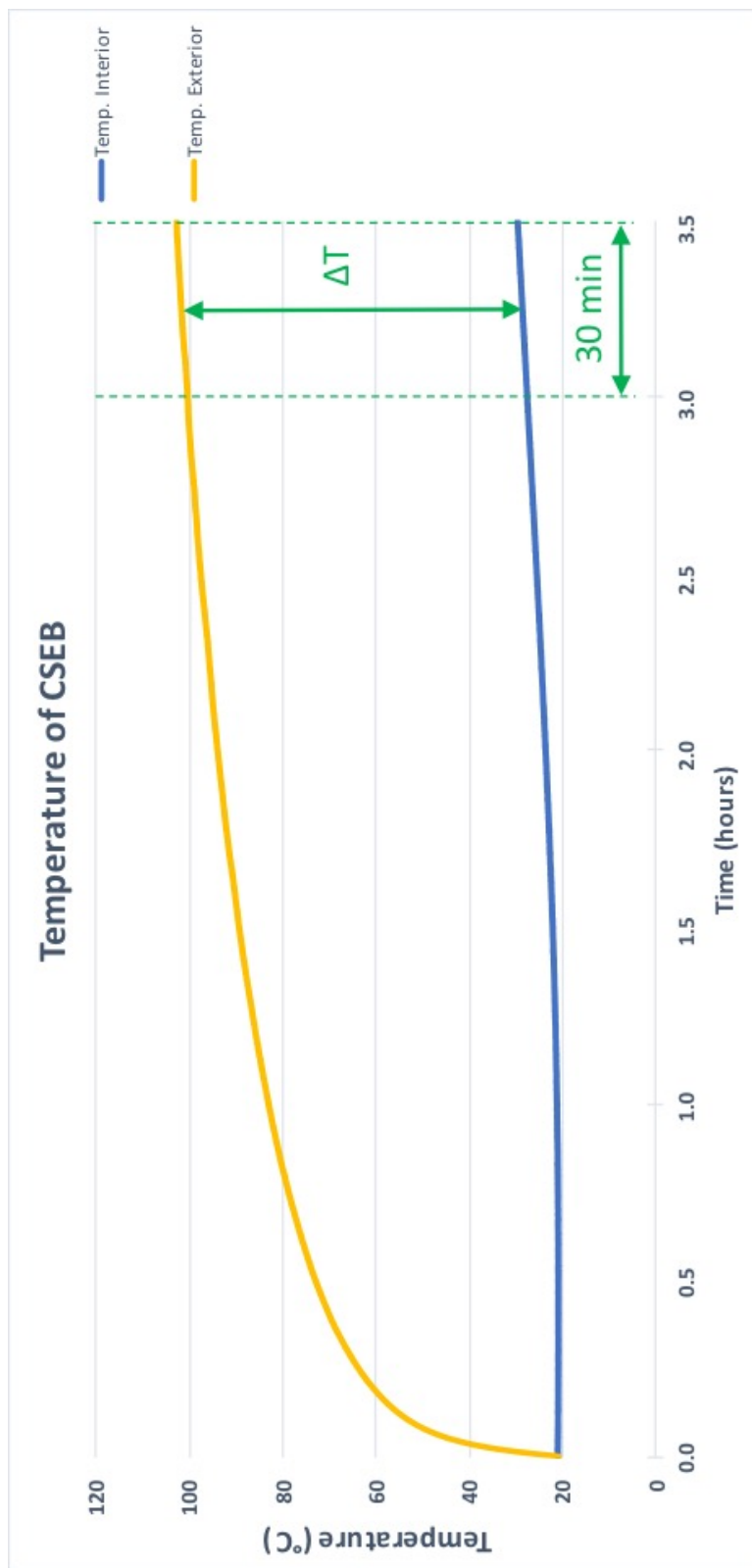

Figure 3-10: Temperature (°C) vs. Time (min.)

Figure 3-11 and Figure 3-12 show a typical heat distribution across a CSEB during the testing process. It is apparent that the block becomes extremely warm near the heater after a couple of hours and the side exposed to the protective chamber remains much closer to room temperature.

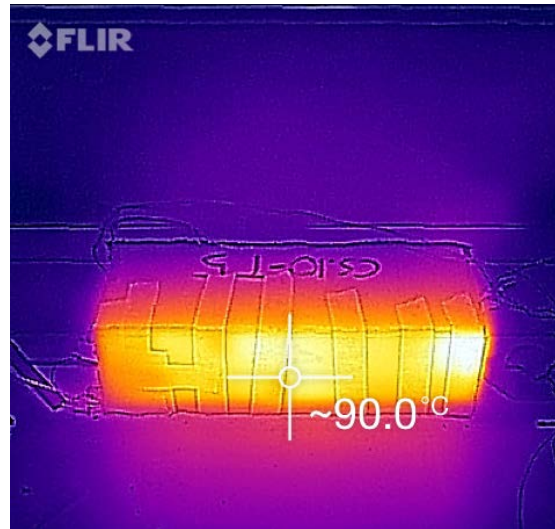

Figure 3-11: Infrared image of uncovered CSEB during heating

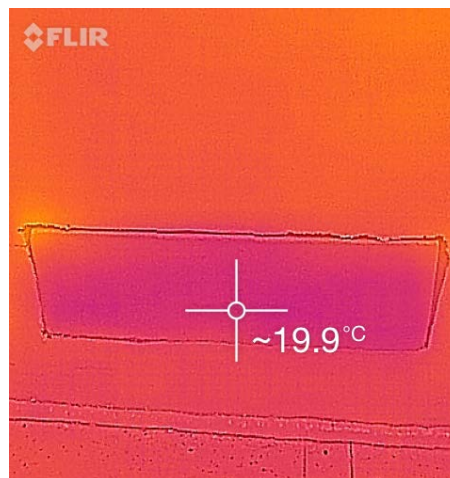

Figure 3-12: Infrared image of CSEB from inside protective chamber during heating

In order to determine the thermal conductivity of the block, an average value must be taken over a period of time. For each data point, the thermal conductivity of the CSEB was calculated using Equation 3.1, where V is the voltage of the heater (V), R is the resistance of the heater in the circuit (ohms), k is thermal conductivity ($W/(m \cdot K)$), A is the area across which the heat is transferring (m^2), T_{out} is the temperature of the block on the outside face (K), T_{in} is the temperature of the block on the inside face (K), and dx is the thickness of the block (m). The heat loss through the insulation covering the CSEB is also considered in the equation where R_i is the R value of the insulation ($5.0 \text{ ft}^2 \cdot \text{h} \cdot ^\circ\text{F}/\text{BTU} \cdot \text{in}$), A_i is the area of the insulation around the block (m^2), dT_i is the temperature differential between the block side and the external insulation (K), and dx_i is the thickness of the insulation (1.5 in or 0.0381 m.)

$$\frac{V^2}{R} = kA \frac{dT}{dx} + \frac{1}{R_i} A_i \frac{dT_i}{dx_i} \quad (\text{Eq. 3.1})$$

$$dT = T_{out} - T_{in}$$

Equation 3.2 and Equation 3.3 detail the calculations used to determine the resistance and voltage across the heater. The subsequent power produced by the heater and delivered to the hot box system is given in Equation 3.4.

$$R = \frac{V^2}{W}; V = 120V, W = 360W \quad (\text{Eq. 3.2})$$

$$R = \frac{120^2}{360W}$$

$$R = 40\Omega$$

$$V_{heat} = V_{circuit} * \frac{R_{heat}}{R_{circuit}} \quad (\text{Eq. 3.3})$$

$$V_{heat} = 120V * \frac{40\Omega}{(50\Omega + 50\Omega + 40\Omega)}$$

$$V_{heat} = 34.3V$$

$$q_{heat} = \frac{V_{heat}^2}{R_{heat}} \quad (\text{Eq. 3.4})$$

$$q_{heat} = \frac{34.3V^2}{40\Omega} = 29.4 W \pm 17.9\%$$

Throughout the 3.5-hour test period the thermal conductivity of each block decreased and slowly approached a steady value, as illustrated in Figure 3-13. An average value across the last 30 minutes of testing was taken as a verified thermal conductivity of each block once it reached a steady-state.

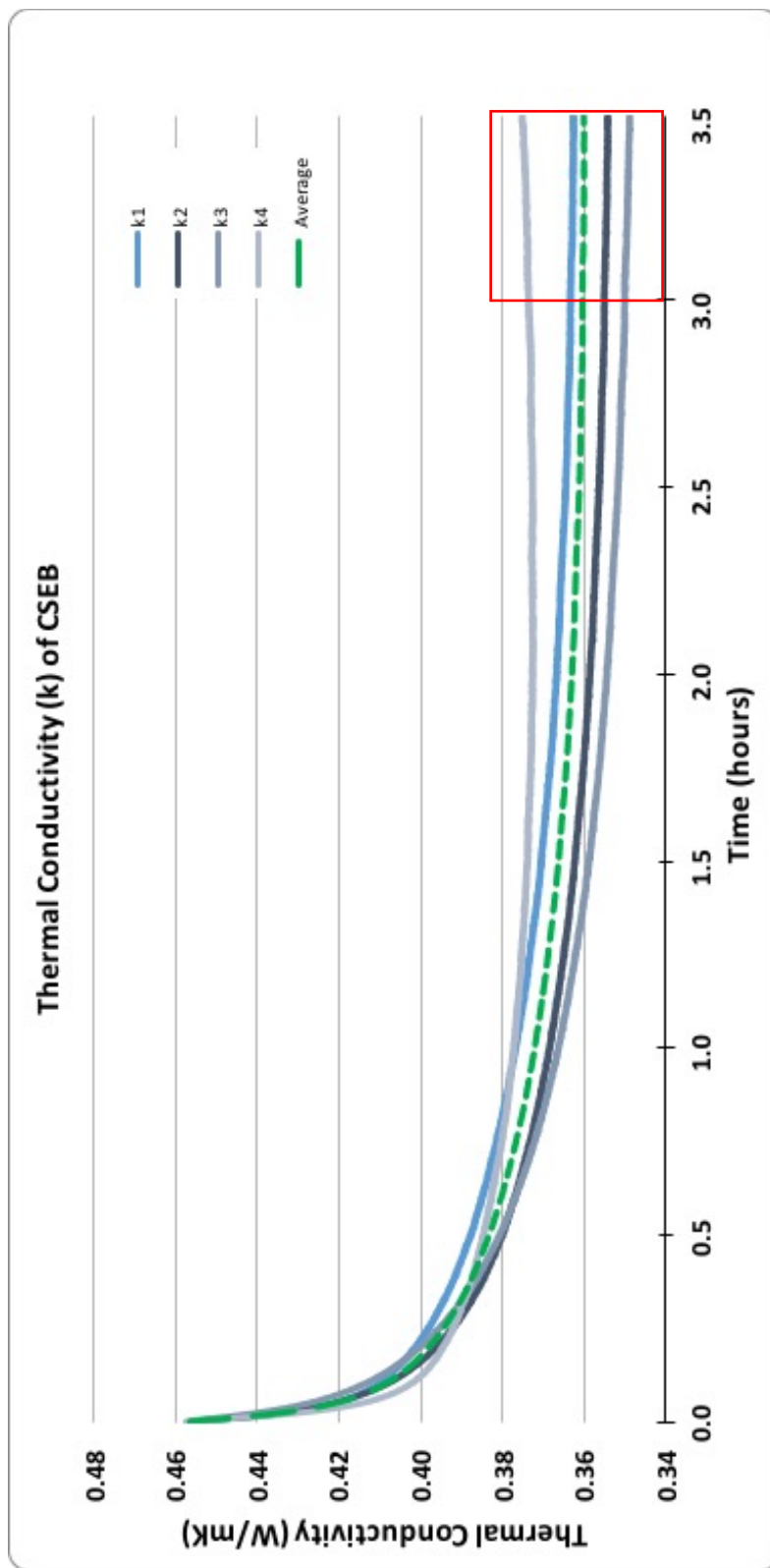

Figure 3-13: Thermal Conductivity of a typical CSEB

3.4. Thermal Test Results and Discussion

Thermal conductivity values are presented in Table 3-2 along with each block's variable dimensions. A total of 5 blocks were analyzed in this study and the average thermal conductivity found throughout the entire testing program was 0.361 W/(m·K).

Table 3-2: Thermal Conductivity Results

Block	Area (m ²)		Thickness (m)		Density (kg/m ³)		Thermal conductivity (W/m·K)	
T1	0.0283	± .05%	0.156	± .03%	1802	± .06%	0.362	± 20.0%
T2	0.0284	± .05%	0.159	± .03%	1838	± .06%	0.366	± 20.0%
T3	0.0286	± .05%	0.155	± .03%	1799	± .06%	0.355	± 20.0%
T4	0.0283	± .05%	0.155	± .03%	1822	± .06%	0.360	± 20.0%
T5	0.0281	± .05%	0.155	± .03%	1821	± .06%	0.361	± 20.0%
Average =							0.361	± 20.0%
Standard Deviation =							0.0039	

A thermal conductivity value of 0.361 W/(m·K) for a CSEB with 10% cement content and a density of 1816 kg/m³ falls well within the expected range based off of the values found in the literature review. Specifically, Balaji et al. (2015) reports a similar density range of 1700-1900 kg/m³ and a cement content range of 5-16%. The reported differing thermal conductivity from the study was 0.842-1.303 W/(m·K) with a clay content varying between 16% and 31.6%. Since the clay content of soil in the Balaji study is

much higher than the clay content of the soil used in this experimental program, a lower thermal conductivity reported here is justified.

Chapter 4 : Life Cycle Analysis Study

Life Cycle Analysis (LCA) is a tool with a holistic perspective on the impacts of a certain product or process (Baumann and Tillmann 2004). In relation to the built environment, a LCA focuses on embodied environmental impacts associated with the design process and building management, and provides a quantitative analysis to guide intelligent design choices and reduce unnecessary impacts (O'Connor et al. 2012).

This study conducts an LCA which specifically compares CSEB masonry to fired clay brick masonry and follows guidelines set forth by the International Organization for Standardization's (ISO) 14040 series ("ISO 14040:2006 - Environmental Management -- Life Cycle Assessment -- Principles and Framework" 2006; "ISO 14044:2006 - Environmental Management -- Life Cycle Assessment -- Requirements and Guidelines" 2006).

4.1. Life Cycle Analysis Methodology

The methodology used in this LCA includes the following steps. Each step is elaborated further within this section:

- 1) Define the scope and system boundary of the study.
- 2) Select two types of construction alternatives for comparison and define a functional unit.
- 3) Define three indicators to compare the two masonry systems.

- 4) Collect Life Cycle Inventory (LCI) data from existing LCA studies of earth masonry and clay brick for cradle-to-gate phases.
- 5) Convert the LCI data for both CSEB and clay brick by multiplying by an area factor to reach the fundamental unit.
- 6) Calculate the energy consumption and associated impacts during the transportation phase of each construction material option.
- 7) Combine the LCI data gathered and calculated from Steps 4-6 to provide relevant data for analysis.

4.1.1. Scope and System Boundary

The goal of this LCA study is to understand the economic and environmental impacts of selecting CSEB masonry instead of conventional clay brick as a building material alternative for use in residential construction. To have a common basis for comparison a simple single family dwelling (Figure 4-1) was chosen. The structural design of this unit was completed by previous studies by Erdogmus et al. (2015a) and Wagner et al. (2013). The hypothetical dwelling is situated on the Winnebago Native American Reservation in the northern Nebraskan plains. It was previously analyzed as CSEB masonry and contains a storm shelter designed to withstand high, tornadic wind speeds.

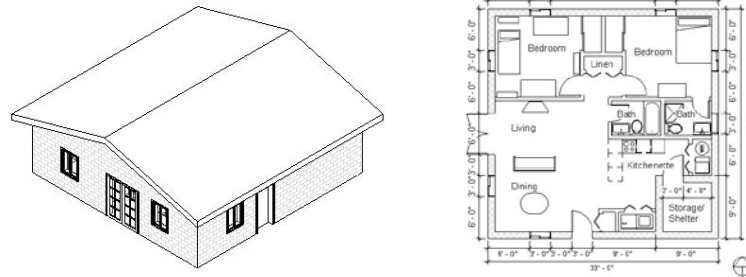

Figure 4-1: Single family dwelling in 3D (left) and plan view (right) (Erdogmus et al. 2015a)

The focus of this study is narrowed to the impacts of just one external wall section composed of either CSEB or clay brick. This includes impacts associated with the blocks only, and not those associated with the necessary mortar or reinforcement for construction. Also not included in analysis are the crucial tools for processing and manufacturing CSEB, as their specific lifespans largely exceed their use in the manufacturing and construction processes in this study. Not only does this study consider the production of CSEB and clay brick, but also the energy used to create the blocks.

The system boundary, illustrated in Figure 4-2 and described in Table 4-1, for this LCA includes three life cycle phases: raw material extraction, manufacturing, and transportation. It is a cradle-to-site analysis with the inclusion of the transportation phase to account for the fact that the CSEB is manufactured on site.

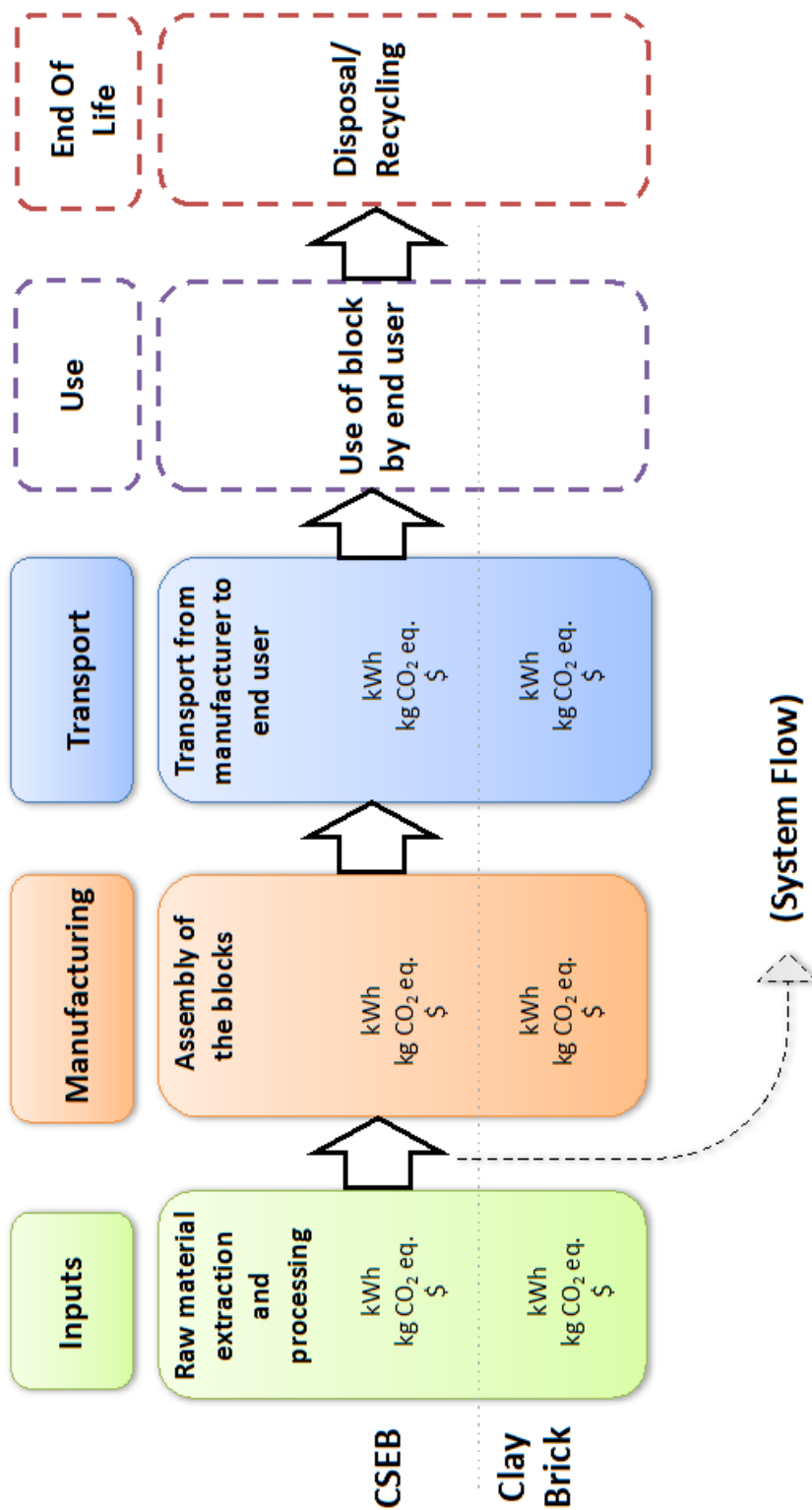

Figure 4-2: System Boundary of LCA study

Table 4-1: Summary of Life Cycle Phases Used in the LCA

LIFE CYCLE PHASE	INCLUDED?	SUMMARY OF PHASE
<u>Inputs</u> (Raw materials extraction)	✓	This phase accounts for the emissions and resource usage resulting from the extraction of the raw materials needed to construct each block. The extraction of raw materials associated with power generation for the electricity is not considered within the system boundary.
<u>Manufacturing</u> (Processing and assembly of blocks)	✓	The manufacturing phase considers the processes involved in manufacturing the block out of the raw materials and the assembly of the blocks into walls during construction, which occurs at the manufacturing site for CSEB. It considers the energy used throughout the process of manufacturing the blocks, as well as the emissions associated with fabricating each block. Additional accessories required by masons during the construction of the wall are assumed to be equivalent between material alternatives and, thus, excluded from the scope of this study.
<u>Transportation</u> (Transporting from manufacturing site to construction site)	✓	The phase of the life cycle where each block is distributed from the manufacturer to the end user is considered in this study. Transportation of manufactured blocks is only considered for clay brick as CSEBs are manufactured on the construction site. The transportation stage of the CSEB life cycle is considered as transportation of any raw materials to the construction site.
<u>Use</u> (Use of blocks by end user)	X	Under the limited scope of this LCA, the energy use, GWP, and the cost associated with the use of these blocks as components in the building envelope are not included in this study. Analysis during the use phase of the building is limited only to effects of varying thermal conductivity during snapshot days. These calculations are provided outside of this LCA for supplemental

		discussion. For purposes of simplifying this study, additional exterior and interior finishing, as well as insulation, are not included for analysis. For the sake of consistency, necessary maintenance and replacement throughout the lifetime of the structure is also excluded from the system boundary. The effect of the exclusion of the maintenance during the use stage has on the results are considered negligible since various studies have shown they amount to approximately 1% of the total life cycle energy cost (Peng 2016).
<u>End of Life</u> (Disposal/recycling of blocks after use)	X	The end of life choices for disposal or recycling these blocks are numerous and greatly dependent on location, services and regulations. In attempts to tighten the scope of this study and ensure its findings would be applicable to other locations, this phase of the life cycle is not included in the system boundary.

4.1.2. Construction Material Selection and Definition of Function Unit

Two different building materials were chosen as alternatives for residential construction for this comparative analysis: CSEB and clay brick. CSEBs were chosen as the primary material to be investigated due to the ongoing research on the sustainable and structural features of this building system at the University of Nebraska. The other material is a more conventional material, clay brick, and it was selected due to its similarity in natural raw material use and construction techniques.

The considered CSEB block, featured in Figure 4-3, has a composition of 10% cement and 90% soil, dimensions of 12-1/8" x 6-3/16" x 3-11/16"^B and an average weight of 17.348lb^C. The clay brick considered in this study comes from Yankee Hill Brick & Tile, a regional manufacturer located in Lincoln, NE, 112 miles from the tribal council offices in Winnebago, NE. The typical unit chosen for analysis, illustrated in Figure 4-4, is the "Utility" brick because it is the closest in volume to the CSEB. An interview with the plant superintendent was required about the product's specifications as limited information on the product is available publically. According to the plant, the exact dimensions of the brick are 11-5/8" x 3-5/8" x 3-5/8" with a 25% void volume. The utility block weighs 9.166lbs (Bailey 2016).



Figure 4-3: CSEB fabricated at University of Nebraska- Lincoln

^B Exact dimensions vary since three measurements were recorded and averaged for each block.

^C Average weight listed here differs from that listed during the experimental thermal study in Chapter 3. This average weight was taken from a more extensive manufacturing process (for a study that has yet to be published) in which 180 blocks were made over the course of 4 days. All assumptions on manual labor in this chapter were reasoned from experience during this study.

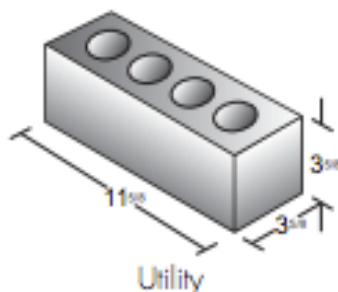

Figure 4-4: Typical Clay brick used in this study

The fundamental unit for comparison in this study is a 5ft segment of an exterior single-story 12ft residential wall. This unit was chosen with regards to the varying volume of each block type.

4.1.3. Defined Indicators

The global building sector is a notable contributor to environmental impacts, such as primary energy consumption and CO₂ emissions, with an average annual increase in each category of about 2% (Pérez-Lombard et al. 2008). Additionally, reduction in total embodied energy present in construction materials has the potential to result in substantial economic gains during raw material extraction and manufacturing processes for any given project (Graham and Booth 2012). Due to the desired outcome of a low-cost material in this study, environmental and economic efficiency are considered paramount. Therefore, the indicators for measuring environmental or economic impacts of each material alternative in this study are Energy (measured in kWh), Global Warming Potential (GWP) (measured in kg CO₂ eq.), and Cost (measured in US Dollars).

4.2. Collected Life Cycle Inventory (LCI)

The following information is used to gather data for the cradle-to-gate portion of the study for the three indicators: Energy, GWP and Cost. Due to a lack of existing data on CSEB as a whole, existing LCI data was used for soil and cement separately, instead. Most data retrieved is reported in units of weight (kg) and subsequently converted to a per block basis as the given weights for each block type is known. All conversion factors for the subsequent calculations are outlined in Table 4-2.

Table 4-2: Conversion Factors

1 kg =	2.2046	lb
1 kg =	0.0010	tonnes
1 km =	0.6214	miles
1 kJ =	0.9478	BTU
1 short ton =	2000	lb
1 kJ =	0.000278	kwh

4.2.1. Indicator 1: Energy

CSEB

The raw material extraction phase of the life cycle of CSEB requires the energy consumption from the cement component as 4464 kJ/kg cement (Peng 2016). Soil can be manually extracted on site by the end user as shovels work perfectly well for the magnitude of soil that needs to be processed for a single-family dwelling. However, due to the amount of organic material present in the top 2ft of soil, digging to a greater depth is desired for more consistent soil and will result in a greater cost of labor.

During the manufacturing process of the CSEB the only electricity usage would come from either a mechanical sieve to separate the finer particles from the larger aggregates, a power mixer to aid in the homogeneous mixing of the soil and cement, and/or a hydraulic block press to speed up production. In order to simplify the calculations, all manufacturing processes of the engineered earth blocks - including sieving, mixing, and compression - will be considered “by hand” and, thus, no energy consumption and related CO₂ emissions will result. Since masonry construction is still considered a manual process, no energy is consumed during the assembly of the wall with regards to either material alternative within the scope of this study. Finally, during the curing process, a typical CSEB loses about 0.4% weight. Therefore, the ratio of weights of final CSEB to raw material extracted is taken as 0.996:1.

Clay Brick

The raw material extraction of clay brick consumes 2000 kJ/kg clay (Peng 2016) during the mining process. During the manufacturing process it is noted that there is a 10% weight loss during the drying and firing process (Bailey 2016). Therefore, the ratio of weights of final clay content in a brick to weight of clay extracted will be taken as 0.9:1. According to Yankee Hill Brick & Tile, the manufacturing process consumes 1100 BTU/lb or 2559 kJ/kg.

4.2.2. Indicator 2: GWP

CSEB

The raw material extraction phase of the life cycle of CSEB produces 0.894 kg CO₂ emissions per kg of cement (Peng 2016). Again, extracting soil from the ground results in no GWP associated with the process, as long as it is entirely manual. Remaining consistent with the energy calculations, the ratio of weights of final CSEB block to weight of raw material extracted will be taken as 0.996: 1. Furthermore, no GWP is associated with the manual manufacturing of CSEB.

Clay Brick

During the raw material extraction of clay brick, 0.2 kg CO₂ is emitted into the atmosphere per kg of clay extracted (Peng 2016). Remaining consistent with the energy calculations the ratio of weights of final clay content in a brick to weight of clay extracted will be taken as 0.9: 1. According to the EPA's Waste Reduction Model data, manufacturing clay bricks emits 0.27 metric tons of CO₂ eq. per short ton ("EPA - Waste Reduction Model [WARM]: Clay Bricks" 2015) or .298 kg CO₂/kg of clay.

4.2.3. Indicator 3: Cost

CSEB

The cost of raw material extraction for a CSEB can be estimated based on the cost of labor and the cost of what it takes to get supplies to the construction site. A 47lb bag of

cement costs \$9.99 at the local Pender, NE Ace Hardware store (“Quikrete® Portland Cement (1124-47)” 2016) and 2lbs are needed for every block, assuming the purchasing price of cement from a local home improvement store includes cost of raw material extraction, manufacturing and transport to store. Soil is free of cost if the end user is extracting it from the construction site and retains property rights.

Based on experience, an able-bodied individual could fill and mechanically sieve one 55-gallon barrel of unprocessed soil in about 2 hours. In the case of sieving by hand, the time should be doubled to about 4 hours. The current minimum wage in Nebraska is \$9.00/hour which would cost the end user \$36/raw barrel extracted and processed.

Depending on density and granularity of the soil, sieving should yield a minimum of 50% usable soil. Therefore, \$72/barrel of useable soil should be considered. Each barrel holds about 200 kg of sieved soil, thus, monetarizing each barrel by weight yields \$0.362/kg.

It has been deduced by the research team based on experience that a three-person crew can conservatively produce 15 blocks per hour at high quality control. Without regard for controlled measurement or curing processes in the field, the rate of manufacturing blocks should be doubled and increase to 30 blocks per hour. At \$9.00/hour for each laborer, each block costs \$0.90/block or \$0.11/kg to manufacture. Finally, labor cost during construction is not included in the scope of this study as earth masonry construction is comparable to conventional brickwork in skills, technique and rates of construction (Morton et al. 2005), thus cancelling each other out.

Clay Brick

It is assumed that the purchasing price of clay masonry from a retailer encompasses the total cost of raw material extraction and manufacturing. Therefore, according to Yankee Hill Brick & Tile, they can manufacture a utility brick at \$0.60/brick cost to the company and mark it up for sale price to \$0.85/brick (Bailey 2016). This price is relatively low since the raw material extraction occurs on site and no transportation costs are included in the process. Since the end user will be purchasing the brick from the company, the sale price is used for cost calculations.

Table 4-3 outlines the collected LCI data separated out by each phase in the life cycle and then by component.

Table 4-3: Summary of Life Cycle Inventory data

Life Cycle Phase	Construction Material	Process	Unit Energy Consumption (kJ/kg)	Unit CO2 Emissions (kg/kg)	Cost (\$/kg)
Raw Material Extraction and Processing	CSEB	Soil	0	0	0.363
		Cement	4482	0.898	0.054
	Clay Brick		2222	0.222	---
Manufacturing	CSEB	Soil	0	0	0.114
		Cement			
	Clay Brick		2559	0.298	0.227

4.3. LCI Data Conversion

All LCI results are converted into terms of one masonry unit (either a CSEB or clay brick) and then normalized in terms of this fundamental unit for comparison across life cycle stages. In order to normalize, the equivalency in terms of a “by volume” basis has been

chosen as it is reasoned that the significant differing factor is the number of blocks needed to construct the 5ft segment of the wall. According to the LCI data for clay brick, an estimated 5% of total material is damaged and discarded during installation (NIST 2011). An assumption is made that the same installation casualty rate applies to CSEB construction as well and is factored into the calculations. Table 4-4 outlines these calculations with the inclusion of a ½” mortar joint between all blocks. Note that mortar joints are included in this volume calculation, yet all other impacts associated with the mortar use for the masonry assemblies are outside the scope of this investigation.

Table 4-4: Block equivalency

Block Type	Area (in ²)	Total Area (in ²) per 5ft x 12ft wall	# Blocks per 5ft x 12ft wall	Clay Blocks per CSEB
CSEB	43.87	8640	140.36	1.23
Clay Brick	42.14	8640	172.75	

** With 5% losses during installation

4.4. Transportation Phase Calculations

The CO₂ emission factor for road freight used in this study is 1.68E-4 tonne/(tonne-km) (Peng 2016). This factor is applied to the transportation of the clay brick after manufacturing in Lincoln, NE – 112 miles or 69.6 kilometers away from the construction site. The 172.75 clay bricks necessary to construct the 5ft wall segment weighs a total of 718.21 kg resulting in 8.40 kg CO₂/5ft wall segment. The average energy consumption factor found for road freight via truck ranged from 4.5 to 7.1 kWh/t-km (García-Álvarez

et al. 2013). Using the conservative end of this range, total energy consumption for the transportation of the clay bricks is 354.88 kWh/5ft wall segment.

Recent regional flatbed rates are \$2.17/mi (“DAT Trendlines™: National Flatbed Rates” 2016) which calculates out to \$243.04 total for the required travel distance. This is a flat rate inclusive of average gas prices and distance travelled, but independent of weight or total bricks transported. It is important to note that the total number of clay bricks used for construction of the single family home under consideration in this study reaches about half the weight capacity of a class 7 flatbed truck (DOE 2012). Therefore, only one trip from the manufacturer to the construction site needs to be made for the brick materials for the entire structure. The transportation costs associated with any 5ft wall segment is equal to the costs of the entire shipment since the bricks will travel together. Furthermore, potential uses for the remaining capacity of the truck is outside the scope of this investigation.

Finally, since the cement to be used in the manufacture of CSEB can be purchased at a local hardware store in Pender, NE, the price of the cement is assumed to include all transportation costs from manufacturer to retailer. To transport the cement from the store to the construction site, the same flatbed rates, emission and energy consumption factors will be used. It is assumed that the maximum distance a construction site can be from the hardware store and still considered to be on the reservation is 30 miles.

Therefore, the energy consumption, GWP and cost associated with transporting the

cement to the site for use in a 5ft wall segment is 146.18 kWh, 3.46 kg CO₂, and \$65.10, respectively.

A summary of the transportation phase calculations can be found in Table 4-5.

Table 4-5: Transportation Phase Data

Life Cycle Phase	Construction Material	Energy Consumption (kWh/5ft wall segment)	Unit CO ₂ Emissions (kg/5ft wall segment)	Cost (\$/5ft wall segment)
Transportation	CSEB	146.18	3.46	65.10
	Clay Brick	354.88	8.40	243.04

Chapter 5 : Life Cycle Analysis Results and Discussion

As previously mentioned, the three indicators of interest were energy use, global warming potential, and economy. These indicators were investigated on cradle-to-site life cycle inventory data with a functional unit of a 5ft segment of exterior wall on a single-story residential dwelling on the Winnebago Native American Reservation in Nebraska. For each indicator, the data provided is calculated for one segment of wall made of CSEB and one segment of wall composed of clay brick masonry. The gathered LCI data was combined from section 4.2 and 4.3, and was added to the transportation phase calculations in section 4.4 for all three indicators. The total life cycle impacts of each type of construction material are presented in Table 5-1, Table 5-2, and Table 5-3

5.1. Indicator 1: Energy Use

Table 5-1: Energy Consumption (kWh) per 5ft wall segment

Energy Consumption (kWh)		
per 5ft wall segment		
	CSEB	Clay Brick
Raw Materials Extraction and Processing	137.51	443.34
Manufacturing	0.00	510.45
Transportation	146.18	354.88
Total	283.69	1308.67

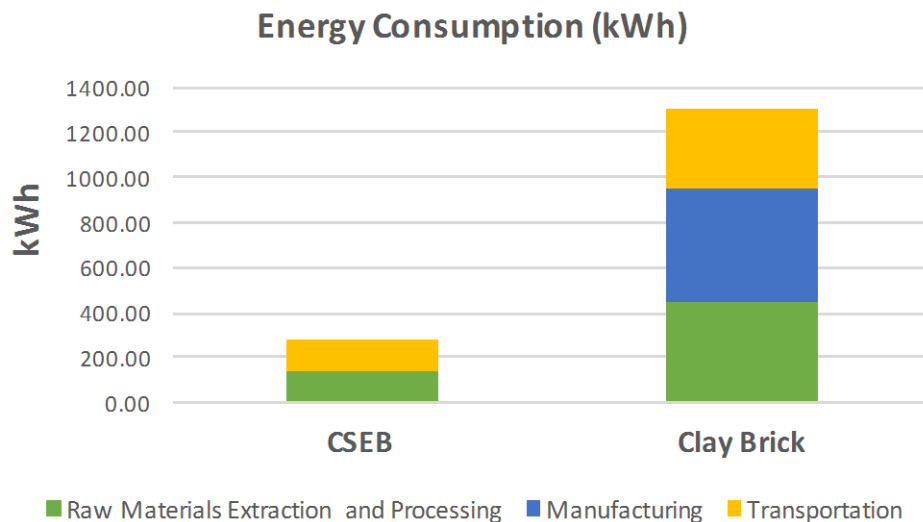

Figure 5-1: Results of LCA - Energy Consumption Comparison

The large difference in energy consumption between clay brick and CSEB can be mostly attributed to the manual development of CSEB by extracting, sieving, and mixing soil by hand, and using a manual block press. This result was expected as (Morton et al. 2005) noted that earthen masonry has minimal environmental impacts during the production process compared to conventional alternatives. As pointed out by Erdogmus et al. (2015b), CSEBs require a smaller amount of energy to produce than clay brick as they do not require firing or a variant heating/cooling treatment in a kiln. Additionally, engineered earthen masonry contains cement for increased strength and durability, however this addition reduces their sustainable performance due to a higher embodied energy than unstabilized earthen masonry (Williams et al. 2010). Reddy (2009) reports an embodied energy of CSEB as 0.5-0.6 GJ/m³ (considering 4 MJ/kg of cement specific energy) compared to an embodied energy of burnt clay brick masonry = 2-3.4 GJ/m³.

The second reason for higher embodied energy in clay brick than in CSEB is due to the transportation phase of the life cycle. Local CSEB production using indigenous soils minimizes energy use associated with the transfer of materials to construction sites (Erdogmus et al. 2015b). The minimal transportation impact on CSEB is the transfer of cement to the construction site, whereas clay brick requires a very large shipment in comparison.

Of total energy consumption worldwide, approximately 10% is the result of the manufacturing and transportation phases of life cycle of traditional construction materials (Williams et al. 2010). The results of this impact category consistently align with the argument that CSEB is the more sustainable building material option.

5.2. Indicator 2: GWP

Table 5-2: Global Warming Potential (kg CO₂ eq.) per 5ft wall segment

Global Warming Potential (kg CO₂ eq.) per 5ft wall segment		
	CSEB	Clay Brick
Raw Materials Extraction and Processing	99.14	159.60
Manufacturing	0.00	213.76
Transportation	3.46	8.40
Total	102.60	381.76

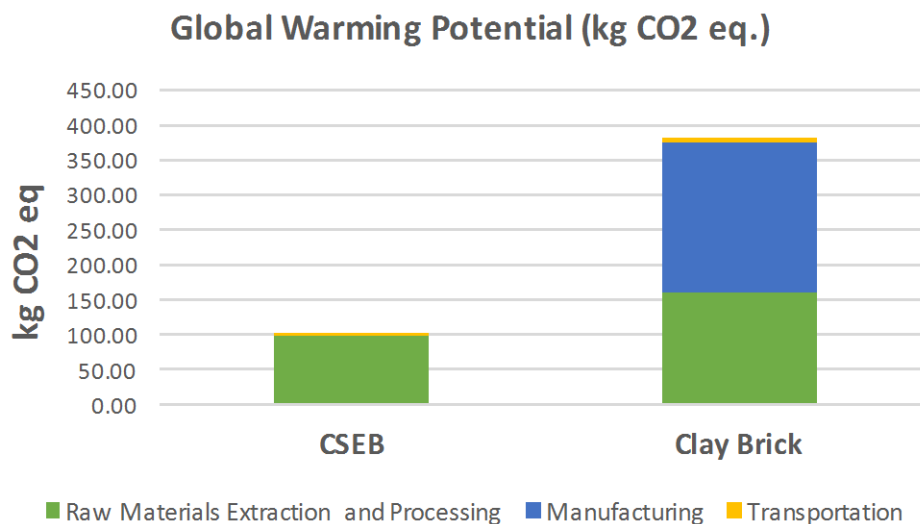

Figure 5-2: Results of LCA - Global Warming Potential (GWP) Comparison

The effects of global warming potential are very similar to the embodied energy results in that the impacts from extracting raw material and manufacturing CSEB are related only to the production of the cement which account for only 10% of the total CSEB by weight. The much larger GWP of clay brick results from complex manufacturing processes with high energy input. However, if clay brick were being compared to a block made solely of cement, it would become the more environmentally sustainable option.

If the transportation phase were not included in this life cycle analysis, the effects on total GWP would be minimal. This is because the GWP associated with the transportation phase of the two building options results from the freight emission factor which is only dependent on weight and distance travelled. For reference, the total GWP associated with the transportation of the cement in the CSEBs that make up the 5ft wall

segment is roughly equal to the GWP from manufacturing 3 clay bricks and can be considered negligible.

5.3. Indicator 3: Cost

Table 5-3: Cost (\$) per 5ft wall segment

Cost (\$)		
per 5ft wall segment		
	<u>CSEB</u>	<u>Clay Brick</u>
Raw Materials Extraction and Processing	367.06	---
Manufacturing	126.32	163.15
Transportation	65.10	243.04
<u>Total</u>	<u>\$558.48</u>	<u>\$406.19</u>

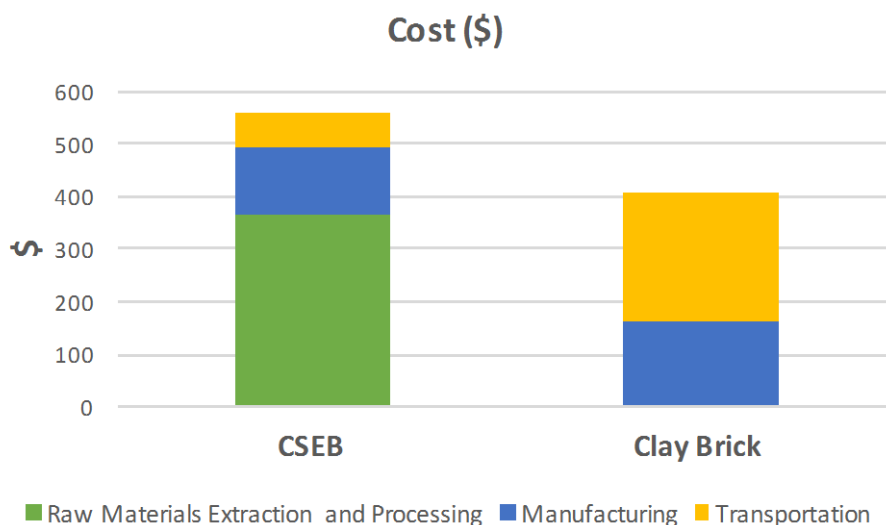

Figure 5-3: Results of LCA – Cost Comparison

The cost differences between CSEB and clay brick are highly situational in this study. The main factor affecting the cost of clay brick is the cost of shipment during the transportation phase of the lifecycle, whereas transporting the cement used in

manufacturing CSEB (a lighter material with a shorter travel distance) is cheaper. The 112 miles that the clay brick has to travel between Lincoln and the Winnebago Reservation is not inconsequential, however it is very much a local site for Yankee Hill Brick & Tile, a company that provides masonry materials for the construction industry all over the nation. Therefore, the 112 miles for clay brick transport should not be considered an outlying effect on the results.

Interestingly, fuel economy barely plays a role in the cost of transport in this study. This is due to the fact that with an increase of fuel efficiency of large transport vehicles, as predicted by the department of energy (NESCCAF et al. 2009), the transportation cost for the cement and the clay brick would decrease proportionally, thus causing no effect. Regardless, had the transportation phase not been included in this analysis, CSEB would still be a more expensive material for residential construction.

Labor costs play a significant role in the overall cost of CSEB because of inefficient manual processes. In a broad sense, non-fired earth is a cost effective method of construction for low-rise housing due to cheap materials, especially in developing countries. However, small-scale production most often results in high unit costs. Earth block construction rarely competes economically at a small scale with the more conventional construction processes using cement or fired clay. For this reason, the modern era has seen a decline of earth block construction in developed countries that stems from the higher cost of labor that is necessary for earth construction compared to more conventional alternatives such as timber or masonry (Williams et al. 2010).

Realistically, the CSEB labor costs would rarely be monetarized as they are in this study because the labor itself would likely be performed by the owner and future resident of the dwelling. However, the labor costs represent a tradeoff for potential paid work the labor is replacing. Depending on the owner's own economic valuation, the cost associated with producing and constructing a residence composed of CSEB may be effectively reduced to zero, thus making the CSBE the cost effective option.

Chapter 6 : Uncertainty and Sensitivity Analysis

There are two types of uncertainty to address within this project: uncertainty within the data collected and uncertainty within the methodology.

6.1. Uncertainty within the data collected

During the thermal testing, measurement uncertainty from the equipment was collected and combined to determine the uncertainty of the reported value of thermal conductivity of the CSEB. The manufacturers' specifications of uncertainty for the thermocouples ($\pm 2.2^\circ\text{C}$ or 3.0%), strip heater ($\pm 1\%$), and power resistors ($\pm 10\%$) were used along with the standard deviation from the mean of all thermal conductance data used in accordance with the guidelines for evaluating reporting uncertainty of measurement results by NIST (Taylor and Kuyatt 1994). Uncertainty in dimensional measurements used with a ruler were conservatively estimated to be $\pm 1/16''$ (0.03%) in each direction. Shown below, Equation 6.1 rearranges Equation 3.1 in order to solve for k and Equation 6.2 demonstrates a typical error propagation calculation through Equation 6.1 by use of the root sum of the squares.

$$k = \left(\frac{V^2}{R} - \frac{1}{R_i} A_i \frac{dT_i}{dx_i} \right) \left(\frac{dx}{dT} \right) \frac{1}{A} \quad (\text{Eq. 6.1})$$

$$A = L \cdot H \quad (\text{Eq. 6.2})$$

Where, A = Cross sectional area of block (m)
 L = Length of block (m)

H = Height of block(m)

$$\frac{\Delta A}{A} = \left[\left(\frac{\Delta L}{L} \right)^2 + \left(\frac{\Delta H}{H} \right)^2 \right]^{\frac{1}{2}}$$

Where,

$$\frac{\Delta L}{L} = \frac{.03\%}{100} = .0003$$

$$\frac{\Delta H}{H} = \frac{.03\%}{100} = .0003$$

And,

$$\frac{\Delta A}{A} = \sqrt{(.0003)^2 + (.0003)^2} = .0004 = \frac{.04\%}{100}$$

As reported in Table 3-2, the CSEBs in this study have an average thermal conductivity of 0.361 W/(m·K) with an average uncertainty of $\pm 20.0\%$. This relatively high uncertainty is largely attributed to the 10% tolerance reported by the power resistor manufacturer for each resistor.

Most of the LCI data used in the study is reported from secondary data sources. The data sources used for this study include some uncertainty because the data was not collected first hand and little transparency to calculation is present in most studies cited. Due to difficulty in quantitatively analyzing the uncertainty in the collected data, emphasis is made in analyzing the LCA methodology as it is assumed that the data used is as accurate as possible for the purpose of this study.

6.2. Uncertainty and sensitivity analysis within the methodology

Several assumptions were made within the report that create cases of uncertainty. For instance, the lack of available cost data on CSEB yielded approximate findings. The procedure of approximation was based on empirical data by the authors with the tools at their disposal in the lab. In order to further understand the implications of the labor costs assumptions, a sensitivity analysis was conducted on the efficiency of the manual labor during the raw material extraction phase of the CSEB life cycle. Figure 6-1 demonstrates the effects of altering the assumption that it takes four hours for a team of three people to extract and process a 55-gallon barrel of soil. Both cases are investigated in which the time of labor for each barrel of unprocessed soil is increased to six hours or cut in half to two hours.

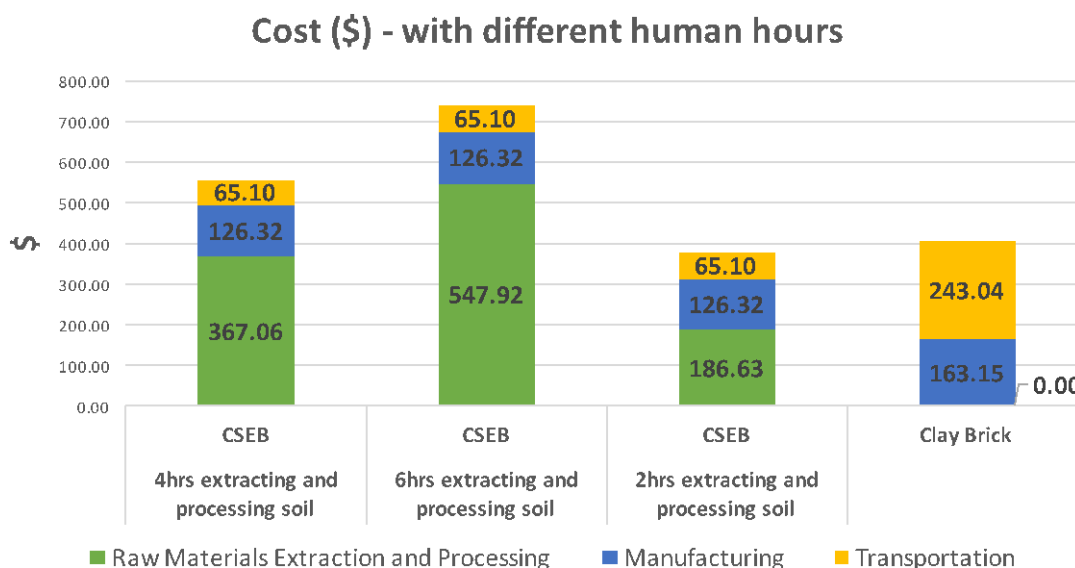

Figure 6-1: Sensitivity to varying labor efficiency in CSEB raw material extraction

It is evident in this study that reducing the approximate processing time per barrel down to two hours of manual labor allows CSEB to be competitive in terms of cost with clay brick. In this case, both material alternatives would cost about \$400 per 5ft wall segment.

This level of efficiency is reasonable to figure since the original judgement that four hours would be sufficient was based on doubling empirical data due to experience in the lab. In practice, it only took about two hours for three people to shovel soil from a pile, dry it out during a warm spring day, and mechanically sieve it by about 20lbs at a time. Consequently, manual labor results can vary in other CSEB processing and manufacturing applications depending on a variety of factors. These factors may include - but are not limited to - the particular consistency of soil, moisture content of extracted soil, number of laborers and tools available, experience of the laborers. It is quite possible to remove soil from the ground and sieve it immediately in cases that the moisture content is not too high that the soil clumps together and that the sieving process is well-organized.

Another assumption made during the Life Cycle Analysis is that all soil processing and CSEB manufacturing is completed manually. A second sensitivity analysis is conducted in order to investigate the additional energy consumption associated with use of electricity for combining the soil-cement mixture during the manufacturing phase of the life cycle. Figure 6-2 demonstrates the impacts of this alternate method base on using a 7-amp power drill operating at 120 volts for 60 seconds for each 5-gallon bucket.

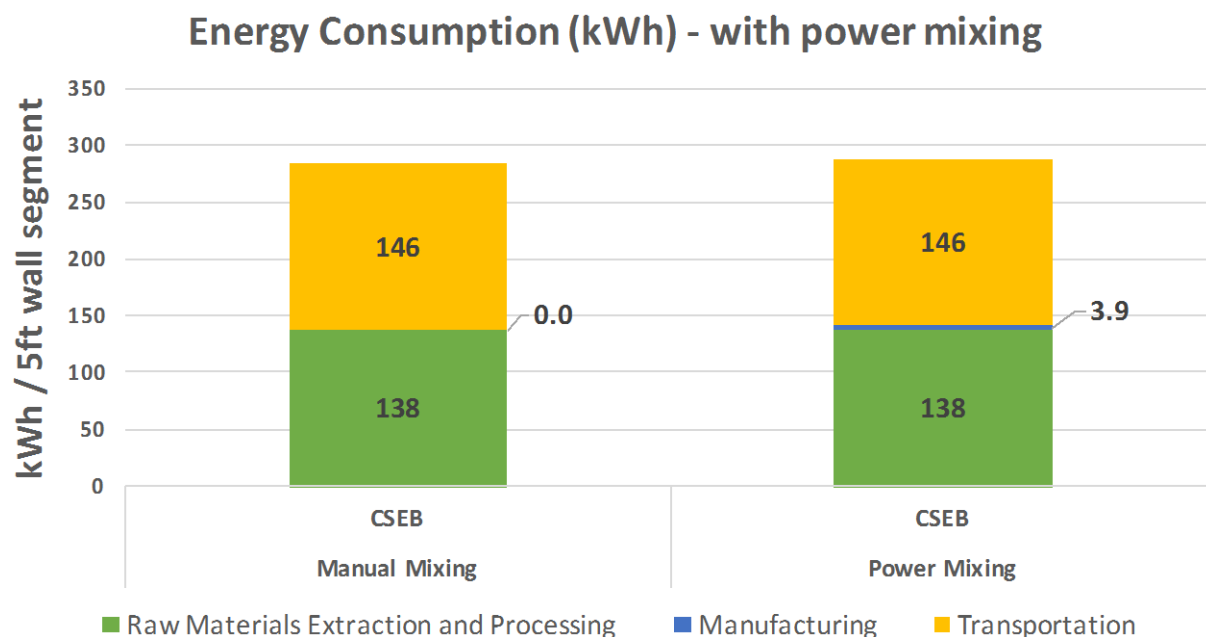

Figure 6-2: Sensitivity to use of power drill in CSEB mixing

The use of a power drill to mix the soil and cement requires an additional 0.028 kWh per block or about 3.9 kWh per 5ft wall segment. This equates to under 1.4% of the total CSEB energy consumption of the life cycle phases under consideration in this study. Further, in comparison with the energy consumption of the clay brick alternative (1300 kWh), the additional energy required to power mix the soil and cement is negligible. Therefore, the assumption that this process was entirely manual has no effect on the results.

The final sensitivity analysis is conducted in order to investigate the implications of assumption that the clay brick is manufactured in Lincoln and must travel 112 miles to reach the construction site. Figure 6-3 demonstrates the effects of reducing or

increasing the transportation distance between the manufacturer and the construction site.

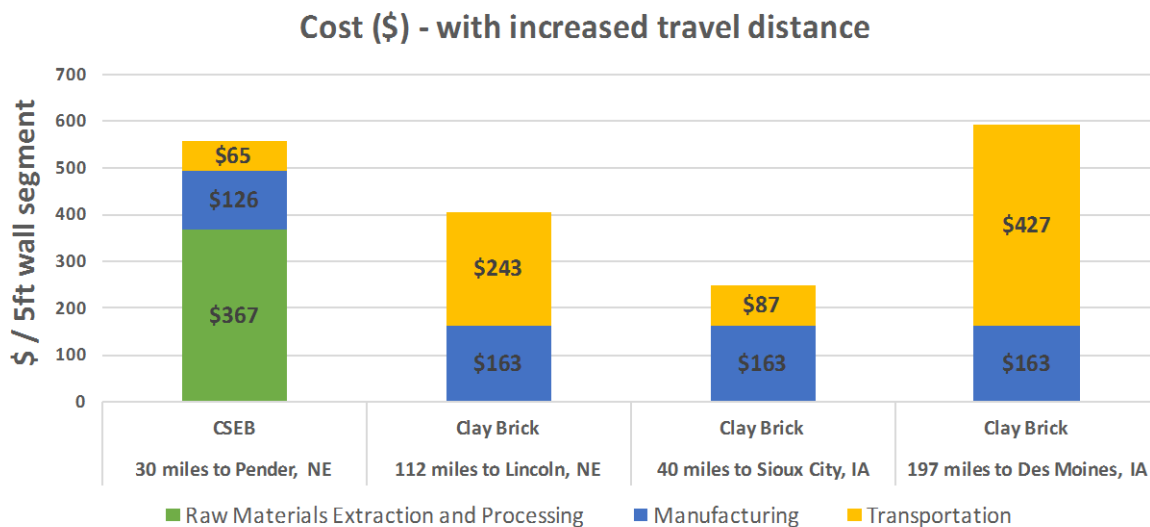

Figure 6-3: Sensitivity to increased travel distance of clay brick

It is apparent that the controlling cost of clay brick over CSEB can be negated by transporting the clay brick as little as 85 miles further than originally positioned. The manufacturer originally selected in Lincoln, NE was chosen based on proximity and familiarity. It is reasonable that a potential end user on the Winnebago Reservation would, instead, receive bricks from either Sioux City, IA or Des Moines, IA – both large cities within a 200-mile radius.

After discussion with the original manufacturers in Lincoln, NE, it was determined that any direct delivery from the manufacturer is rather unlikely as most large facilities contract with third party regional distributors. These distributors often cause increase travel costs as they are dispersed around the country, however their participation in the

transportation phase of the life cycle is outside the scope of this study. Consequently, it is adequate to note that transportation costs are highly dependent on travel distance and efficiency. In order to accurately compare the relative cost differential of CSEB compared to a clay brick alternative, factors such as availability, clay brick type and location of the distribution center must be weighed.

Beyond these sensitivity analyses, it is also known that significant research shows earth based mortars (often composed of soil, sand and cement) are more appropriate for use with CSEB (Ouda 2009) than traditional Type N or S mortar. However, all mortar was ignored in this study, except for use during volume calculations, in order to focus on the comparison between two block materials. Had mortar associated with each building material type been included, additional costs would be found associated with the extraction and processing of sand, as well as more soil, for CSEB and additional cement for both masonry systems. Further, mortar on the construction site also necessitates a water supply which opens up potential for further assumptions based on how that water arrives at the site.

Finally, as previously mentioned, the use and end of life phases for each building material alternative was not taken into account in this study. If end of life data were to be included in this study, the overall impacts for the three indicators would likely increase. The intentional exclusion of the use and end of life impacts are a point of uncertainty that has the small potential to change the results to favor one construction alternative option more strongly than the other. However, due to current state of

recycling brick in the construction and demolition industry, it is reasonable to figure that the end of life options for CSEB would be similar to those of clay brick, and thus, very environmentally sound.

Chapter 7 : Applied Thermal Conductivity Impacts

As previously stated, the thermal resistance of probable insulation and other wall components common to a residential building that would generally be factored into total thermal resistance of the wall are outside the scope of this study. The analysis provided in this chapter is contained to a strict comparison of the effects of the different thermal conductivities between CSEB and clay brick.

The thermal conductivity for CSEB found in Chapter 3 was 0.361 W/(m·K). Equation 2.1 (Dondi et al. 2004) for determining thermal conductivity of clay brick based on bulk density from the literature review in Chapter 2 will be used in this analysis. Considering a 25% void ratio, the bulk density of the utility brick is 2214 kg/m³. Substituting this value into Equation 2.1 results in a thermal conductivity for clay brick of 1.024 W/(m·K), and this value will be used in this study.

Unit thermal conductance, U , is the thermal conductance for a unit area of material and can be determined by dividing the thermal conductivity of a material by its thickness, as demonstrated in Equation 7.1 (McQuiston et al. 2005).

$$U = \frac{k}{\Delta x} \quad (\text{Eq. 7.1})$$

The heat transfer rate in each component of a building system is then given by,

(Eq. 7.2)

$$\dot{q} = UA\Delta t$$

Where,

\dot{q} = heat transfer rate (W)

U = unit thermal conductance (W/m²·K)

A = surface area normal to flow (m²)

Δt = overall temperature difference (K)

For a true Life Cycle Cost study, a comprehensive hour-by-hour and day-by-day parametric analysis would be conducted including variables related to building design, location, climate, orientation of the building, and analysis period (often lifetime) (Ghattas et al. 2016). Since these factors are outside the scope of this study, simplified snapshot studies are conducted to provide an informative picture of the impacts related to the differences in thermal conductivity between CSEB and clay brick during different seasons of the year.

For example, the outside air temperature can easily reach a typical winter day average of 0°C (32°F) in eastern Nebraska while most homes try to maintain a comfortable interior temperature of about 20°C (68°F). Considering this potential temperature differential and both a thickness and surface area unique to each block, Table 7-1 details the heat transfer rate in the form of heat loss for both the CSEB and clay brick during a possible day in the winter season.

Table 7-1: Heat transfer rate of CSEB and Clay Brick

Construction Material	Thermal Conductance (W/mK)	Thickness (m)	Unit Thermal Conductance (W/m ² K)	Area (m ²)	Heat transfer rate (W)
CSEB	0.361	0.156	2.32	0.0283	1.312
Clay Brick	3.252	0.092	35.32	0.0272	19.204

This heat loss aggregated over a 24-hour snapshot day accounts for 1.312 kWh and 19.204 kWh additional heating load attributed to the use of either one CSEB or one clay brick, respectively. Table 7-2 demonstrates similar energy consumption calculations concerning a possible, yet undefined, snapshot day during the spring, summer and fall seasons due to the different thermal conductivities of the materials.

Table 7-2: Energy costs per typical seasonal day for each block

Season	Winter	Spring	Summer	Fall
Outdoor Temp.	0	15	35	30
Indoor Temp.	20	20	20	20
Temp. Differential	20	5	15	10
Construction material	24 hour heat loss (kWh)			
CSEB	0.031	0.008	0.024	0.016
Clay Brick	0.461	0.115	0.346	0.23

7.1. Indicator 1: Energy Use

In consideration for this heat loss demonstrated across seasons in Table 7-2, additional energy consumption equal to the loss is necessary to maintain status quo in the residence. Figure 7-1 illustrates the comparison of additional energy consumption between CSEB and clay brick for the entire 5ft wall segment.

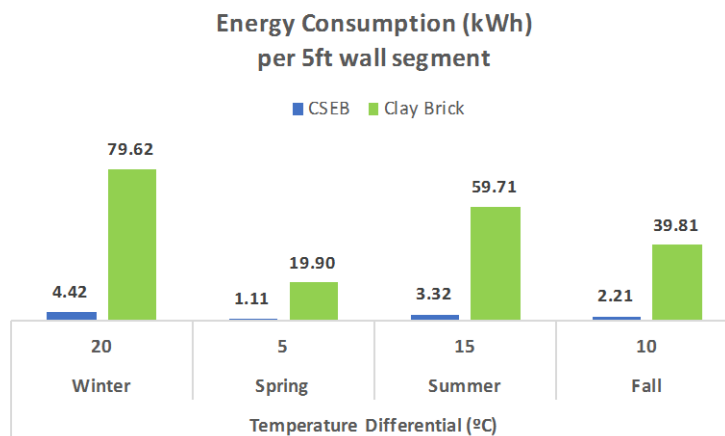

Figure 7-1: Thermal Conductivity: Energy Consumption (kWh) per 5ft wall segment

7.2. Indicator 2: GWP

The U.S. Environmental Protection Agency's report on GHG annual output emission rates lists the MRO West eGRID region as having an annual output emission rate of 1,425.15 lb CO₂ /MWh (EPA 2015). Figure 7-2 exhibits the further global warming potential from the additional energy consumption necessary to compensate for the different thermal conductivity of the respective blocks.

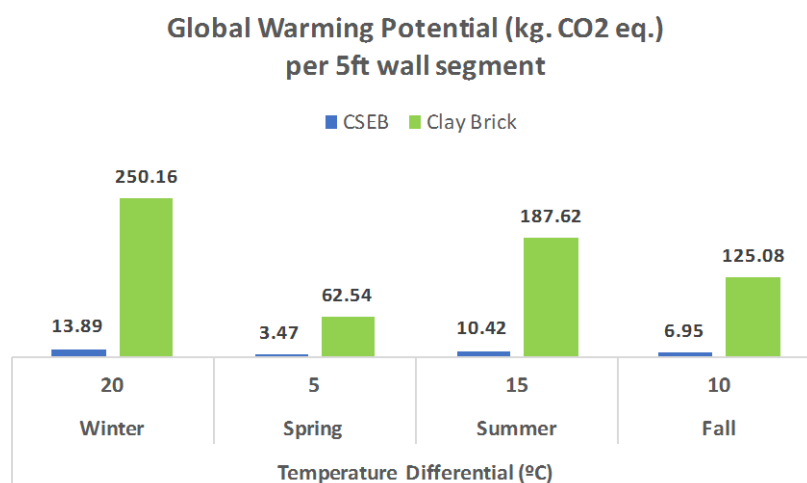

Figure 7-2: Thermal Conductivity: Global Warming Potential (kg CO₂ eq.) per 5ft wall segment

7.3. Indicator 3: Cost

According to the U.S. Energy Information Administration, the average cost per kWh in Nebraska in August 2016 was \$0.12 (EIA 2016). Figure 7-3 converts the information in Figure 7-1 on energy consumption into the cost difference between CSEB and clay brick due to differing thermal conductivities across the four seasons.

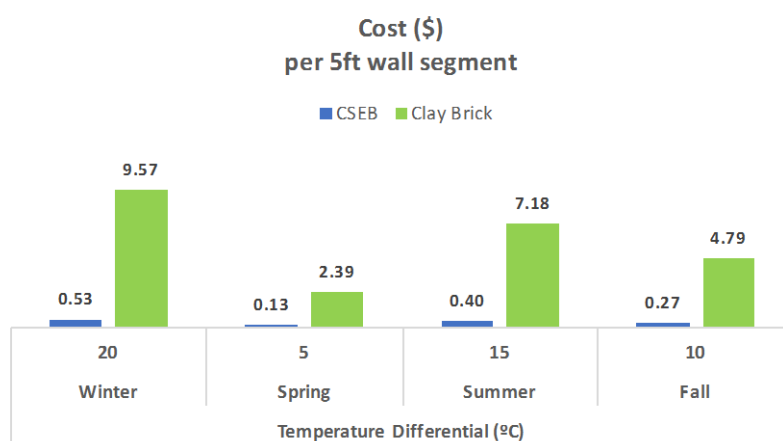

Figure 7-3: Thermal Conductivity: Cost (\$) per 5ft wall segment

The apparent impacts of different thermal conductivities between CSEB and clay brick result in over 10 times the energy consumption across all seasons for clay brick than needed for CSEB. This increased energy consumption correlates to a higher global warming potential (250 kg CO₂ eq.) for clay brick than for CSEB (14 kg CO₂ eq.).

Substantially, clay brick could cost \$9.00 more in heating costs per 5ft wall segment during the winter months.

Chapter 8 : Conclusions

The potential for minimizing specific environmental impacts (CO₂ emissions and energy use) and economic impact (cost) associated with the use of CSEB have been assessed and the objectives of this study were met:

- 1) The thermal conductivity of the CSEB considered in this study was determined to be $0.361 \text{ W}/(\text{m}\cdot\text{K}) \pm 20.0\%$. This value was compared to the thermal conductivity of clay brick, $1.024 \text{ W}/(\text{m}\cdot\text{K})$, using a density relationship found in the literature. By comparison, CSEB can exhibit a third of the thermal conductivity of clay brick.
- 2) A Life Cycle Analysis was conducted in order to compare the CSEB and clay brick. CSEB was determined to have about a quarter of the embodied energy and global warming potential of clay brick since the later results from energy intensive manufacturing processes. Additionally, CSEB proves to have a higher economic cost due to labor during the raw material extraction. However, the costs associated with transporting clay brick are highly sensitive to distance transported and have the ability to offset these CSEB labor costs in certain scenarios.

Ultimately, the embodied energy of engineered earthen masonry can be minimized by maintaining manual processes in which soil extraction, sieving and mixing is done by hand. The tradeoff of these manual practices is a longer, more labor intensive construction process. However, for many communities who are potential users of this construction method, the manual process is the most cost

effective solution.

Despite the additional labor costs, the local and small-scale nature of engineered earthen masonry construction is ideal in terms of sustainability due to the reduced environmental impacts caused by mass production processes and transportation often seen in the construction industry. In order to reduce cost of an earth block construction project, use of previously discarded soil from nearby excavations should be prioritized (Williams et al. 2010). This practice would eliminate cost of labor during the raw material extraction phase of the life cycle.

- 3) The potential impact of choosing CSEB instead of clay brick in a building envelope in terms of differing thermal conductivity was investigated. Based on thermal conductivity, CSEB results in greatly reduced energy consumption, global warming potential and economic cost, saving up to 95% heating and cooling costs. Interestingly, some studies estimate that houses comprised primarily of heavy masonry will be able to provide comfortable living conditions without air conditioning until 2061, however houses that are timber framed will likely need additional cooling by 2021 (Williams et al. 2010). The thermal properties of CSEB have proven to aid sustainability efforts by providing increased thermal resistance to the building envelope. This allows for minimal heat loss compared to conventional alternatives with additional energy and cost savings along with reduced global warming potential.

Further examination into lifetime of installed CSEB blocks and necessary maintenance of a residential dwelling composed of CSEB is necessary in order to fully encompass the use

phase into the Life Cycle Analysis. In the same regard, investigation into the end of life options for CSEB would make a substantial contribution to the literature on this sustainable building option. Additional research on the complete sustainability of CSEB is necessary in order to determine long term effects on health of potential residents due to indoor air quality concerns pertaining to abundant use of soil in the built environment.

In conclusion, it has been demonstrated that earth construction achieves environmental and economic sustainability by offering material abundance (indigenous soil), opportunities for cost efficiency, and relatively easy manufacturing and construction processes that can be achieved locally. CSEB masonry successfully presents an affordable, durable, sustainable, and locally appropriate construction method.

References

- Adam, E.A., and P.J Jones. 1995. "Thermophysical Properties of Stabilised Soil Building Blocks." *Building and Environment* 30 (2): 245–53. doi:10.1016/0360-1323(94)00041-P.
- ASTM C518. 2015. "Standard Test Method for Thermal Transmission Properties by Means of the Heat Flow Meter Apparatus." ASTM International.
- ASTM C1045-07. 2013. "Standard Practice for Calculating Thermal Transmission Properties Under Conditions." ASTM International.
- ASTM C1113. 1999. "Standard Test Method for Thermal Conductivity of Refractories by Hot Wire (Platinum Resistance Thermometer Technique)." ASTM International.
- ASTM C1363. 2011. "Standard Test Method for Thermal Performance of Building Materials and Envelope Assemblies by Means of a Hot Box Apparatus." ASTM International, West Conshohocken, PA. www.astm.org.
- ASTM D422-63. 2007. "Standard Test Method for Particle-Size Analysis of Soils." ASTM International, West Conshohocken, PA. www.astm.org.
- ASTM D2216-10. 2010. "Standard Test Methods for Laboratory Determination of Water (Moisture) Content of Soil and Rock by Mass." ASTM International.
- ASTM D4318-10e1. 2014. "Standard Test Methods for Liquid Limit, Plastic Limit, and Plasticity Index of Soils." ASTM International.
- Bailey, T. 2016. Interview with Yankee Hill Brick & Tile: Utility Brick. Phone Interview. ted.b@yankeehillbrick.com.
- Balaji, N.C., M. Mani, and B.V. Venkatarama Reddy. 2016. "Thermal Conductivity Studies on Cement-Stabilised Soil Blocks." In *Proceedings of the Institution of Civil Engineers - Construction Materials*. doi:10.1680/jcoma.15.00032.
- Balaji, N.C., K.I. Praseeda, M. Mani, and B.V. Venkatarama Reddy. 2015. "Influence of Varying Mix Proportions on Thermal Performance of Soil-Cement Blocks." In , 67–74. Bolzano, Italy.
- Baumann, H., and A.M. Tillmann. 2004. *The Hitch Hikers's Guide to LCA : An Orientation in Life Cycle Assessment Methodology and Application*. Lund Studentlitteratur.
- Bhattacharjee, B. 1989. "A Study on the Influence of Void and Moisture Contents of Some Building Materials on Their Thermal Transport Properties and Implications

- on Thermal Performance of Building Envelope.” PhD thesis, Delhi, India.: Indian Institute of Technology.
- Colley, E. 2014. “Effects of Polyethylene Terephthalate Fibers in the Water Resistance of Compressed Stabilized Earth Blocks.” University of Nebraska-Lincoln.
- Colley, E., and E. Erdogmus. 2015. “Effects of Cement Stabilization and Fibers on the Water Resistance of Compressed Stabilized Earth Blocks” 33 (1).
- Costa, C. S., F. Rocha, and A. L. Velosa. 2016. “Sustainability in Earthen Heritage Conservation.” *Geological Society, London, Special Publications* 416 (April). doi:10.1144/SP416.22.
- “DAT Trendlines™: National Flatbed Rates.” 2016. *DAT Solutions*. October. <http://www.dat.com/resources/trendlines/flatbed/national-rates>.
- DOE. 2012. “Alternative Fuels Data Center: Vehicle Weight Classes & Categories.” U.S. Department of Energy: Energy Efficiency and Renewable Energy. <http://www.afdc.energy.gov/data/>.
- Dondi, M., F. Mazzanti, P. Principi, M. Raimondo, and G. Zanarini. 2004. “Thermal Conductivity of Clay Bricks.” *Journal of Materials in Civil Engineering* 16 (1): 8–14. doi:10.1061/(ASCE)0899-1561(2004)16:1(8).
- EIA. 2016. “Electric Power Monthly with Data for August 2016.” U.S. Energy Information Administration. <https://www.eia.gov/electricity/monthly>.
- EPA. 2015. “eGRID: U.S. Annual Non-Baseload CO2 Output Emission Rate, Year 2012 Data.” U.S. Environmental Protection Agency. <https://www.epa.gov/energy/egrid>.
- “EPA - Waste Reduction Model [WARM]: Clay Bricks.” 2015. *Environmental Protection Agency (EPA)*. March. https://www3.epa.gov/epawaste/conserve/tools/warm/pdfs/Clay_Bricks.pdf.
- Erdogmus, E., and E. Garcia. 2015. “Influence of Stabilizers on the Compressive Strength of Compressed Stabilized Earth Block Masonry.” In . Denver, Colorado.
- Erdogmus, E., A. Schwer, B. Wagner, E. Garcia, L. Rohe, F. Matta, and E. Obonyo. 2013. “The Compressive Strength of Stabilized and Fiber Reinforced Earthen Mortars: Challenges in Compression Testing, Curing, and Test Result Consistency.” In *Mechanics for Sustainable and Resilient Infrastructure*. Vol. EMI 2013. Evanston, Illinois.
- Erdogmus, E., B. Wagner, L. Rohe, E. Garcia, A. Schwer, F. Matta, and E. Obonyo. 2015a. “Design of Compressed Stabilized Earthen Wall Systems for High-Wind Resistant

- Residential Unit Construction.” In *AEI 2015*, 409–20. American Society of Civil Engineers. <http://dx.doi.org/10.1061/9780784479070.036>.
- . 2015b. “Design of Compressed Stabilized Earthen Wall Systems for High-Wind Resistant Residential Unit Construction.” In *Proc. 6th Biennial Professional Conference for 2015*. Milwaukee, WI. doi:10.1061/9780784479070.036.
- García-Álvarez, A., P. J. Pérez-Martínez, and I. González-Franco. 2013. “Energy Consumption and Carbon Dioxide Emissions in Rail and Road Freight Transport in Spain: A Case Study of Car Carriers and Bulk Petrochemicals.” *Journal of Intelligent Transportation Systems* 17 (3): 233–44. doi:10.1080/15472450.2012.719456.
- Ghattas, R., J. Gregory, M. Noori, R. Miller, E. Olivetti, and S. Greene. 2016. “Life Cycle Assessment for Residential Buildings: A Literature Review and Gap Analysis Rev. 1.” MIT: Concrete Sustainability Hub. DOI: 10.13140/RG.2.2.10238.38722.
- Graham, P., and P Booth. 2012. “UNEP Guidelines on Education Policy for Sustainable Built Environments.” United Nations Environment Programme Sustainable Buildings & Climate Initiative. http://www.unep.org/sbci/pdfs/UNEPSBCI_EducationPolicyGuidelines_2010.pdf.
- “ISO 14040:2006 - Environmental Management -- Life Cycle Assessment -- Principles and Framework.” 2006. International Organization for Standardization.
- “ISO 14044:2006 - Environmental Management -- Life Cycle Assessment -- Requirements and Guidelines.” 2006. International Organization for Standardization.
- Khedari, J., P. Watsanasathaporn, and J. Hirunlabh. 2005. “Development of Fibre-Based Soil–cement Block with Low Thermal Conductivity.” *Cement and Concrete Composites* 27 (1): 111–16. doi:10.1016/j.cemconcomp.2004.02.042.
- McQuiston, F.C., J.D. Parker, and J.D. Spitler. 2005. *Heating, Ventilation, And Air Conditioning*. 6th ed. John Wiley & Sons, Inc.
- Meukam, P., Y. Jannot, A. Noumowe, and T.C. Kofane. 2004. “Thermo Physical Characteristics of Economical Building Materials.” *Construction and Building Materials* 18 (6): 437–43. doi:10.1016/j.conbuildmat.2004.03.010.
- Morton, T., F. Stevenson, B. Taylor, and N.C. Smith. 2005. “Low Cost Earth Brick Construction.” A Partners In Innovation research project final report. 69 Burnside, Auchtermuchty, Fife, KY14 7AJ, U.K.: Arc, Chartered Architects. <http://www.arc-architects.com/downloads/Low-Cost-Earth-Masonry-Monitoring-Evaluation-Report-2005.pdf>.

- Nagih, M.E., and A.A.A. Ali. 1995. "Strength and Thermal Properties of Plain and Reinforced Soil–cement." *Journal of Islamic Academy of Sciences* 8:3: 107–18.
- NESCCAF, ICCT, Southwest Research Institute, and TIAX, LLC. 2009. "Reducing Heavy-Duty Long Haul Combination Truck Fuel Consumption and CO2 Emissions." Final Report.
http://www.theicct.org/sites/default/files/publications/HDVemissions_oct09.pdf
- NIST. 2011. "Life Cycle Analysis for Building Products: Generic Brick." The National Institute of Standards and Technology (NIST).
- O'Connor, Jennifer, J. Meil, S. Baer, and C. Koffler. 2012. "LCA in Construction: Status, Impact, and Limitations." White Paper. Athena Sustainable Materials Institute & PE INTERNATIONAL. http://www.athenasmi.org/wp-content/uploads/2012/08/ASMI_PE_INTL_White_Paper_LCA-in-Construction_status_impact_and_limitations.pdf.
- Omega. 2016. "Thermocouples: Product Info." Omega.
<http://www.omega.com/prodinfo/thermocouples.html>.
- Ouda, K. 2009. "Building with Compressed Earth Blocks: A Report for the Crow Tribe and the U.S. Department of the Interior, Assistant Secretary – Indian Affairs, Division of Energy and Mineral Development." University of Colorado at Boulder.
- Peng, C. 2016. "Calculation of a Building's Life Cycle Carbon Emissions Based on Ecotect and Building Information Modeling." *Journal of Cleaner Production* 112, Part 1 (January): 453–65. doi:10.1016/j.jclepro.2015.08.078.
- Pérez-Lombard, L., J. Ortiz, and C. Pout. 2008. "A Review on Buildings Energy Consumption Information." *Energy and Buildings* 40 (3): 394–98.
 doi:10.1016/j.enbuild.2007.03.007.
- "Quikrete® Portland Cement (1124-47)." 2016. Online Store. *AceHardware.com*.
<http://www.acehardware.com/product/index.jsp?productId=2041962>.
- Reddy, B.V. Venkatarama. 2009. "Sustainable Materials for Low Carbon Buildings." *International Journal of Low-Carbon Technologies* 4 (3): 175–81.
 doi:10.1093/ijlct/ctp025.
- Reddy, B.V. Venkatarama, and A. Gupta. 2005. "Characteristics of Cement-Soil Mortars." *Materials and Structures*, 38 (July): 639–50.
- Reddy, B.V. Venkatarama, and P. Prasanna Kumar. 2010. "Embodied Energy in Cement Stabilised Rammed Earth Walls." *Energy and Buildings* 42 (3): 380–85.

- Reddy, B.V. Venkatarama, and M.S. Latha. 2014. "Influence of Soil Grading on the Characteristics of Cement Stabilised Soil Compacts." *Materials and Structures* 47 (10): 1633–45. doi:10.1617/s11527-013-0142-1.
- Riza, F.V., I.A. Rahman, and A.M.A. Zaidi. 2010. "A Brief Review of Compressed Stabilized Earth Brick (CSEB)." In . Kuala Lumpur, Malaysia. doi:10.1109/CSSR.2010.5773936.
- Taylor, B.N., and C.E. Kuyatt. 1994. "Guidelines for Evaluating and Expressing the Uncertainty of NIST Measurement Results." U.S. Department of Commerce Technology Administration: National Institute of Standards and Technology (NIST).
- UNI 7745. 1977. "Insulating Materials - Determination Of Thermal Conductivity By Means Of The Guarded Hot Plate Method."
- Wagner, B., E. Erdogmus, and A. Schwer. 2013. "Affordable, Sustainable, and Resilient Tornado Shelter Design Using Compressed Stabilized Earth Block Construction." In *Proc. 5th International Conference on Structural Engineering, Mechanics and Computation*. Cape Town.
- Williams, C., S. Goodhew, R. Griffiths, and L. Watson. 2010. "The Feasibility of Earth Block Masonry for Building Sustainable Walling in the United Kingdom." *Journal of Building Appraisal* 6 (2): 99–108. doi:10.1057/jba.2010.15.

Glossary of Terms

Term	Definition
Boundary conditions	The elements that are considered within the scope of a life cycle assessment. In order for two analyses to be comparable, the boundary conditions should be similar
Cradle-to-site	A method of life cycle assessment that considers the environmental impact of a product from materials extraction through its construction, excluding its impact after production (i.e., after leaving the factory floor).
Embodied energy	Embodied energy is the total energy required to produce a product or material.
End of Life	The life cycle period in which the material is no longer in use and must be disposed of, reused for another purpose or recycled.
Environmental impact	The consequence of pollution, such as eutrophication of waterways, ocean acidification or global warming.
Functional unit	Defines the product or process under examination, to which impacts are assigned in a life cycle assessment.
Global warming potential	GWP is a measurement of the how much a certain mass of a chemical contributes to global warming over a certain time period, as compared to carbon dioxide. The GWP of carbon dioxide is 1.0.
Impact factor	The quantification of environmental impact for a particular material or process.
Life cycle assessment (LCA)	A method for determining the environmental impact of a product or process by examining a product's life cycle.
Life cycle cost assessment (LCCA)	A life cycle cost assessment provides a cost for the production and use of a product.
Lifetime	Lifetime refers to the number of years a typical product is in service, typically used to understand the use phase of a product in cradle-to-grave assessments.
Use phase	The period in which a building is occupied and maintained.

LCA and Thermal Calculations

Table A-1: Raw material extraction and manufacturing LCA calculations

Raw Material Extraction and Manufacturing	Clay Brick	CO2 Emissions for Manufacturing	0.27	MTCO2E/ short ton	0.298	kg/kg
		Energy consumption	1100	btu/lb	2559	kJ/kg
		Cost of Utility Block	0.85	\$/block	0.2044	\$/kg
		Weight Yield after firing	0.9	lb/lb		
	CSEB	Cost of cement	9.99	\$/47lb	0.425	\$/block
		Blue Barrel volume	55	gallons		
		Weight of soil in barrel	438.75	lb	199.014	kg/barrel
		Cost of Labor	9	\$/hr		
		Time to process a barrel by hand	4	hrs	36	\$/barrel extracted and processed
		Sieving yield	50	%	72	\$/useable
					0.362	\$/kg
		Time for 3 people to cast 30 blocks	1	hrs	0.900	\$/block
				0.114	\$/kg	
	Weight Yield after curing	0.996	lb/lb			

Table A-2: Transportation LCA calculations

Transportation	Clay Brick	Freight emission factor	1.68E-04	t/(t,km)		
		distance between Lincoln and Winnebago	112	mi	69.594	km
		weight of clay brick/5ft wall	246.911	kg	0.247	tons
					0.003	ton of CO2/wall
					2.887	kg of CO2/wall
		Freight energy factor	7.1	kWh/t-km	494.114	kWh/t
					0.494	kWh/kg
	Freight cost	2.17	\$/mi	243.040	\$	
	Fuel cost	2.44	\$/gallon			
	CSEB	Freight emission factor	1.68E-04	t/(t,km)		
		distance between store and possible site	30	mi	18.641	km
		Total weight of CSEBs	203.698	kg	0.204	tons
					0.001	ton of CO2/wall
					0.638	kg of CO2/wall
Freight energy factor		7.1	kWh/t-km	132.352	kWh/t	
				0.132	kWh/kg	
Freight cost	2.17	\$/mi	65.100	\$		

Table A-3: Applied Thermal calculations

Use	Clay Brick	buld density	2214	kg/m ³
		thermal conductivity	1.024	W/(mK)
thickness		3.625	m	
unit thermal conductance		0.282	W/(m2K)	
Area		42.141	m ²	
Temperature differential		20	degrees C	
Heat Transfer rate		238.037	W	
24hr Heat Transfer		5.713	kWh	
electricity costs		0.120	\$/kWh	
Emission Factor		1,425.15	lb CO2/MWh	
CSEB		thermal conductivity	0.465	W/(mK)
	thickness	6.125	m	
	unit thermal conductance	0.076	W/(m2K)	
	Area	43.866	m ²	
	Temperature differential	20	degrees C	
	Heat Transfer rate	66.622	W	
	24hr Heat Transfer	1.599	kWh	
	electricity costs	0.120	\$/kWh	
	Emission Factor	1,425.15	lb CO2/MWh	

Table A-4: GWP per typical seasonal day for each block

Global Warming Potential				
	Temperature Differential (°C)			
	Winter	Spring	Summer	Fall
	20	5	15	10
Construction Material	CO2 eq. for 24 hour heat loss per 5ft wall segment			
CSEB	130	33	98	65
Clay Brick	1066	266	799	533

Table A-5: Cost per typical seasonal day for each block

Cost				
	Temperature Differential (°C)			
	Winter	Spring	Summer	Fall
	20	5	15	10
Construction Material	(\$) for 24 hour heat loss per 5ft wall segment			
CSEB	\$4.98	\$1.24	\$3.73	\$2.49
Clay Brick	\$40.78	\$10.20	\$30.59	\$20.39

Geotechnical Data

Table A-6: Batch 8 - Dry Sieve Test

Appendix C : Batch 8 - Dry Sieve Test						
Sieve Number	Sieve Weight (g)	Sieve w/ soil Weight (g)	Retained soil weight (g)	Percent Retained (%)	Cumulative Percent Retained (%)	Percent Finer(%)
4	528.15	536.17	8.02	1.3	1.3	98.7
10	446.88	597.64	150.76	24.7	26.0	74.0
20	378.19	627.34	249.15	40.8	66.8	33.2
30	407.59	463.52	55.93	9.2	76.0	24.0
40	380.59	430.45	49.86	8.2	84.1	15.9
50	377.32	399.42	22.1	3.6	87.7	12.3
60	365.16	375.95	10.79	1.8	89.5	10.5
80	355.4	367.66	12.26	2.0	91.5	8.5
100	350.64	354.19	3.55	0.6	92.1	7.9
200	324.54	340.42	15.88	2.6	94.7	5.3
Base	373.49	405.9	32.41	5.3	100.0	0.0
TOTAL	3759.8	4362.49	610.71			
Initial Soil Weight =		610.71				

Table A-7: Batch 8 - Atterburg Limits

Batch 8 - Atterburg Limits								
	Can #	Can Mass(g)	Wet Soil and Can Mass (g)	Wet Soil Mass (g)	Dry soil and Can Mass (g)	Dry Soil Mass (g)	Moisture Content (%)	# of blows
Liquid	311	11.26	49.33	38.07	40.19	28.93	24.01	22
	249	10.76	46.82	36.06	38.31	27.55	23.60	27
	316	11.11	45.62	34.51	37.13	26.02	24.60	17
Plastic	314	11.08	13.37	2.29	12.95	1.87	18.34	--
	256	10.72	13.82	3.1	13.3	2.58	16.77	--
Average Moisture Content at 25 Blows = Liquid Limit:						23.76		
Average Moisture Content of Plastic Limit Test = Plastic Limit:						17.56		
Plasticity Index:						6.21		

Table A-8: Batch 9 - Dry Sieve Test

Batch 9 - Dry Sieve Test						
Sieve Number	Sieve Weight (g)	Sieve w/ soil Weight (g)	Retained soil weight (g)	Percent Retained (%)	Cumulative Percent Retained (%)	Percent Finer(%)
10	421.97	531.6	109.63	20.0	20.0	80.0
20	427.81	618.57	190.76	34.8	54.8	45.2
30	404.82	475.78	70.96	13.0	67.8	32.2
40	392.78	440.65	47.87	8.7	76.5	23.5
50	371.75	417.41	45.66	8.3	84.9	15.1
60	374.03	386.24	12.21	2.2	87.1	12.9
80	354.1	376.09	21.99	4.0	91.1	8.9
100	350.62	356.65	6.03	1.1	92.2	7.8
200	340.68	353.6	12.92	2.4	94.6	5.4
Base	494.54	524.33	29.79	5.4	100.0	0.0
TOTAL	3933.1	4480.92	547.82			
		546.5				

Table A-9: Batch 9 - Atterburg Limits

Batch 9 - Atterburg Limits								
	Can #	Can Mass(g)	Wet Soil and Can Mass (g)	Wet Soil Mass (g)	Dry soil and Can Mass (g)	Dry Soil Mass (g)	Moisture Content (%)	# of blows
Atterberg 1								
Liquid	16	11.76	41.58	29.82	33.98	22.22	25.49	16
	215	11.22	44.62	33.4	36.29	25.07	24.94	20
	301	11.04	40.75	29.71	33.4	22.36	24.74	29
Plastic	320	11.07	12.86	1.79	12.53	1.46	18.44	--
	238	10.84	13.48	2.64	12.97	2.13	19.32	--
Average Moisture Content at 25 Blows = Liquid Limit:						24.83		
Average Moisture Content of Plastic Limit Test = Plastic Limit:						18.88		
Plasticity Index:						5.95		

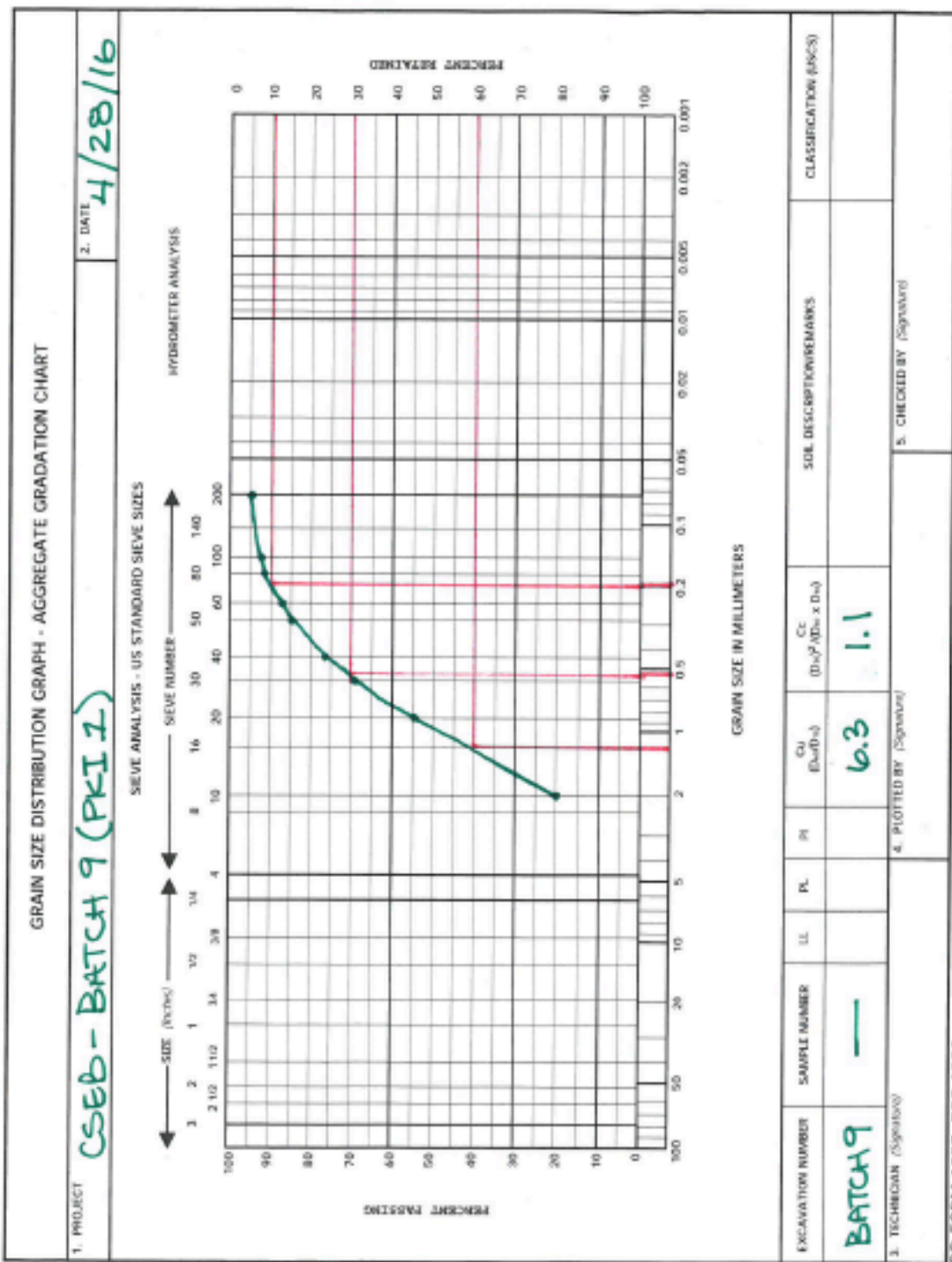

Figure A-1: Batch 9 - Aggregate Gradation Chart

Table A-10: Batch 10 - Dry Sieve Test

Batch 10 - Dry Sieve Test						
Sieve Number	Sieve Weight (g)	Sieve w/ soil Weight (g)	Retained soil weight (g)	Percent Retained (%)	Cumulative Percent Retained (%)	Percent Finer (%)
10	386.13	517.97	131.84	30.9	30.9	69.1
20	432.91	517.18	84.27	19.7	50.6	49.4
30	418.87	453.33	34.46	8.1	58.7	41.3
40	477.55	511.76	34.21	8.0	66.7	33.3
50	374.18	401.44	27.26	6.4	73.1	26.9
60	378.29	391.7	13.41	3.1	76.3	23.7
80	346.31	378.35	32.04	7.5	83.8	16.2
100	351.52	360.73	9.21	2.2	85.9	14.1
200	342.35	388.39	46.04	10.8	96.7	3.3
Base	494.57	508.59	14.02	3.3	100.0	0.0
TOTAL	4002.68	4429.44	426.76			

Table A-11: Batch 10 - Atterburg Limits

Batch 10 - Atterburg Limits								
	Can #	Can Mass(g)	Wet Soil and Can Mass (g)	Wet Soil Mass (g)	Dry soil and Can Mass (g)	Dry Soil Mass (g)	Moisture Content (%)	# of blows
Liquid	5	11.8	50.53	38.73	41	29.2	24.61	18
	250	10.69	47.82	37.13	38.86	28.17	24.13	27
	213	11.2	46.41	35.21	37.79	26.59	24.48	24
Plastic	17	11.86	15.78	3.92	15	3.14	19.90	--
	310	11.21	14.71	3.5	14.02	2.81	19.71	--
Average Moisture Content at 25 Blows = Liquid Limit:						24.36		
Average Moisture Content of Plastic Limit Test = Plastic Limit:						19.81		
Plasticity Index:						4.56		

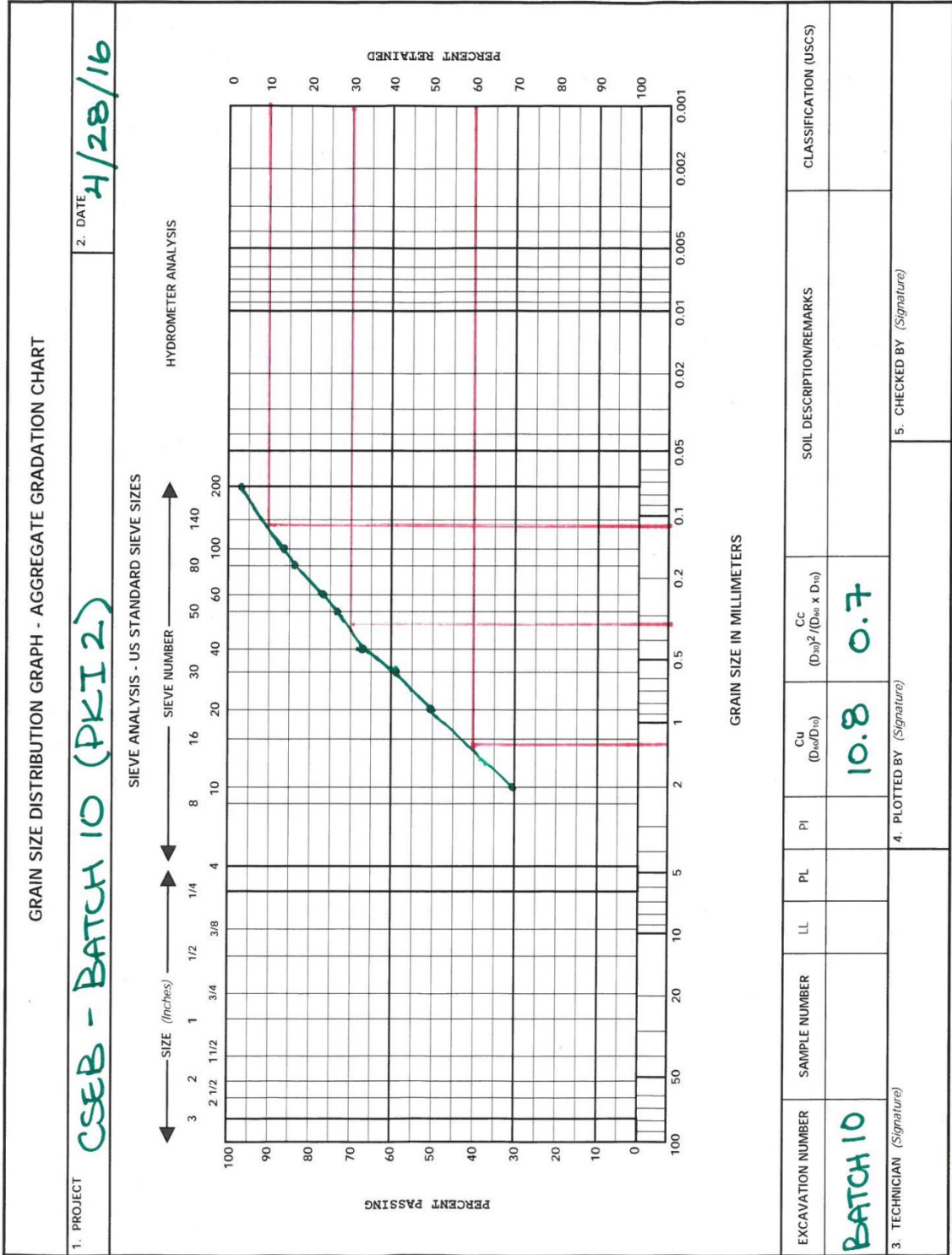

Figure A-2: Batch 9 - Aggregate Gradation Chart